



ARUP



DESIGNING A NET ZERO ROADMAP FOR HEALTHCARE

TECHNICAL METHODOLOGY
AND GUIDANCE



ACRONYMS	04
1 INTRODUCTION	05
1.1 PURPOSE OF THIS METHODOLOGY	06
1.2 WHO SHOULD USE THIS METHODOLOGY?	06
1.3 SOURCES OF EMISSIONS FROM HEALTHCARE	07
1.4 HEALTHCARE-SPECIFIC EMISSIONS SOURCES	09
1.5 THE PROCESS FOR CREATING A ROADMAP FOR HEALTHCARE SYSTEM DECARBONISATION	10
2 TERMS AND DEFINITIONS	11
3 ESTABLISHING GOVERNANCE STRUCTURES FOR DECARBONISATION	15
3.1 UNDERSTAND THE STRUCTURE OF THE HEALTHCARE SECTOR	15
3.2 IDENTIFY KEY STAKEHOLDERS	15
3.3 MAP EXISTING POLICIES AND THEIR SUPPORTING STRUCTURES	16
3.4 MAP EXISTING STRUCTURES AND NETWORKS	16
3.5 DEVELOP A GOVERNANCE STRUCTURE	16
3.6 INCLUDE A PROCESS OF CONTINUOUS IMPROVEMENT	16
3.7 OUTCOMES FROM THIS SECTION	17
4 IDENTIFYING AND MANAGING STAKEHOLDERS	18
4.1 DEFINE INTERNAL AND EXTERNAL STAKEHOLDERS	18
4.2 MAP STAKEHOLDERS AGAINST STAGES OF DEVELOPMENT	19
4.3 ORGANISE AND PRIORITISE STAKEHOLDERS	19
4.4 DEVELOP A STAKEHOLDER ENGAGEMENT STRATEGY	20
4.5 MEASURE AND MANAGE STAKEHOLDERS	21
4.6 OUTCOMES FROM THIS SECTION	21
5 SETTING A BASELINE	22
5.1 STUDY BOUNDARY CONDITIONS (SCOPE)	23
5.2 BASELINE YEAR AND STUDY PERIOD	26
5.3 CALCULATION METHODS (TOP-DOWN, BOTTOM-UP AND HYBRID)	27
5.4 ESTABLISHING A BASELINE USING A TOP-DOWN METHODOLOGY	30
5.5 INCLUDING BOTTOM-UP DATA TO CREATE A HYBRID MODEL	37
5.6 REPORTING FRAMEWORKS	42
5.7 DATA QUALITY	43
5.8 OUTCOMES FROM THIS SECTION	43

6	DERIVING A TRAJECTORY	44
6.1	KEY CONSIDERATIONS WHEN SETTING	45
6.2	FUTURE TRENDS THAT CAN INFORM TARGET TRAJECTORIES	46
6.3	CALCULATING HEALTHCARE NATIONAL BUDGETS	46
6.4	OUTCOMES FROM THIS SECTION	49
7	CREATING A PROJECTION	50
7.1	EXPENDITURE PROJECTIONS IN HEALTHCARE TO 2050	51
7.2	WIDER ECONOMY DECARBONISATION	51
7.3	OUTCOMES FROM THIS SECTION	54
8	MODELLING ACTIONS AND PATHWAYS	55
8.1	USING THE MODEL TO ASSESS DECARBONISATION ACTIONS	55
8.2	IDENTIFYING INTERVENTIONS	56
8.3	ASSESSING REDUCTION POTENTIAL OF ACTIONSS	57
8.4	ADOPTION RATE OF INTERVENTIONS	58
8.5	CALCULATING EMISSIONS GAP	58
8.6	POST-PROCESSING TO CREATE DIFFERENT PERSPECTIVES	58
8.7	OUTCOMES FROM THIS SECTION	60
9	MEASURING, REPORTING, AND VERIFICATION	61
9.1	MEASURING	61
9.2	REPORTING	61
9.3	VERIFICATION	63
9.4	CONTINUOUS IMPROVEMENT	64
9.5	OUTCOMES FROM THIS SECTION	64
	REFERENCES	65
	APPENDIX A EMISSIONS CATEGORIES	67
	APPENDIX B OUTCOMES FROM EACH SECTION	70

ACRONYMS

CO₂	Carbon Dioxide
CO₂e	Carbon Dioxide equivalent
DPI	Dry Powder Inhaler
EEIO	Environmentally-Extended Input-Output
EFDB	Emissions Factor Database
EPA	Environmental Protection Agency
ETP	Energy Technology Perspectives
GDP	Gross Domestic Product
GHG	Greenhouse Gas
GHGP	Greenhouse Gas Protocol
GVA	Gross Value Added
HCWH	Health Care Without Harm
IEA	International Energy Agency
IOA	Input-Output Analysis
IPCC	Intergovernmental Panel on Climate Change
ISIC	International Standard Industrial Classification
ISO	International Organisation for Standardisation
kWh	kilowatt hour
MDI	Metered Dose Inhaler
MRV	Measurement Reporting and Verification
NDC	Nationally Determined Contributions
NGO	Non-Governmental Organisation
NHS	National Health Service
OECD	Organisation for Economic Co-operation and Development
PAS	Publicly Available Specification
SHA	System of Health Accounts
SUT	Supply and Use Tables
UNFCCC	United Nations Framework Convention on Climate Change
WBCSD	World Business Council for Sustainable Development
WHO	World Health Organization
WRI	World Resources Institute



INTRODUCTION

Since the industrial revolution, anthropogenic greenhouse gas (GHG) emissions have risen dramatically. As the most significant contributory factor to our changing climate, these gases have profound consequences for both planetary and human health.

Climate change is already having severe impacts on our health. These include temperature-related illness and death, injuries and illnesses due to extreme weather events, the spread of infectious disease vectors, increases in waterborne illnesses, and wide-ranging impacts from air pollution.

The healthcare sector is on the frontline for dealing with these health impacts. However, as a major emitter, the sector itself is contributing to the problem. In 2019, and in partnership with Arup, Health Care Without Harm (HCWH) published *Health Care's Climate Footprint*¹ – the most comprehensive global analysis of healthcare's contribution to the climate crisis to date. Setting out the healthcare climate footprints of 43 different countries from around the globe, this report highlights the scale of the challenge. As a whole, the global healthcare sector's climate footprint is equivalent to 4.4% of global net emissions and if it were a country, it would be the fifth largest emitter in the world.

In April 2021, HCWH launched its *Global Roadmap for Health Care Decarbonization*.² The Global Roadmap is the first of its kind to chart a global course to zero emissions healthcare by 2050. By including allowances for the development of universal healthcare, the Global Roadmap demonstrates that healthcare can reach net-zero emissions, in both a fair and equitable way.

As a major emitter and a sector left carrying the consequences of climate change, it is imperative for the healthcare sector to take a leading role in tackling the issue. There is no doubt this presents a significant challenge, but it also brings opportunity. Opportunity to lead by example, leverage its purchasing power (10% of GDP in Europe), and influence changes within its supply chain. While health professionals can use their trusted voices to educate on the health impacts of climate change and advocate change.

This Technical Methodology and Guidance document (hereafter referred to as Methodology) has been created to support such endeavours. Developed through HCWH Europe's Operation Zero project, it represents a natural progression of both the Climate Footprint Report and the Global Roadmap. It was developed and tested in partnership with three national and regional health authorities and Arup (see [Table 1](#)). This Methodology was developed **for** the healthcare sector **by** the healthcare sector.

¹ Arup, Health Care Without Harm (2019). Health Care's Climate Footprint. Retrieved from: [HealthCaresClimateFootprint_092319.pdf \(no-harm-global.org\)](#)

² Health Care Without Harm (2021). Global Roadmap for Health Care Decarbonization. Retrieved from: [The Roadmap | Health Care Climate Action](#)

Table 1: Key partners involved in the development and testing of this methodology.

Department of Epidemiology Lazio Regional Health Service (Italy)	
Ministry of Health, Welfare and Sport (Netherlands), National Institute for Public Health and the Environment (Netherlands)*	
Central Administration of the Health System (Portugal)	
Radboud University Medical Centre (Netherlands)	

* The Netherlands National Institute for Public Health and the Environment (RIVM) exchanged knowledge and information within the Operation Zero project with the involved stakeholders and is not an author of this publication. Work prepared by RIVM for Operation Zero ("case study Netherlands team") was performed independently and commissioned by the Dutch Ministry of Health Welfare and Sports (sustainable health care program), with no relations with or requirements from the client of Health Care Without Harm. Parallel in-depth studies for the Dutch healthcare system are performed and will be available in fall 2022 (in English on the website [Green Deal Duurzame Zorg | RIVM](#)).

1.1 PURPOSE OF THIS METHODOLOGY

The purpose of this Methodology is to provide any national or regional health authority with a set of guiding principles and methods that will allow it to adopt a common approach in measuring its healthcare emissions and to develop a decarbonisation roadmap that is compatible with the 2015 Paris Agreement.

The responsibility for addressing healthcare's significant GHG emissions is often devolved to individual healthcare providers. Reducing these emissions, however, is a collective effort that requires strategic direction and support from the top. By adopting this Methodology, national and regional health authorities can calculate their collective healthcare carbon footprint, identify relevant hotspots, and set a common pathway for decarbonisation. Adopting a more strategic approach will facilitate better resource allocation and policy development.

1.2 WHO SHOULD USE THIS METHODOLOGY?



Primary audience: Many of the processes outlined within this Methodology, e.g. utilising input-output models, calculating a carbon footprint, and modelling emissions trajectories, are of a technical nature and require specialist skills. This Methodology is therefore aimed primarily at analysts working within national or regional health authorities, who have experience in calculating GHG emissions or working with complex data sets. Staff members with the relevant skills and professional experience that would be useful within the project team include statisticians and data analysts, economists, and carbon/environmental managers. Based on pilot countries' experience, it takes approximately 30-50 days to complete the processes described in the Methodology. The actual time will depend on whether a national

data collection programme is undertaken or if global datasets are used, as well as the level of subsequent analysis carried out.

Secondary audience: Policy officials working within national or regional health authorities are a secondary audience for this Methodology. Some sections may be more relevant to their skillsets and areas of influence, such as developing appropriate governance structures and convening relevant stakeholders. Furthermore, there is a need to ensure policy oversight when developing a decarbonisation roadmap for healthcare, to ensure appropriate policy measures can be developed and implemented to secure its long-term success.

1.3 SOURCES OF EMISSIONS FROM HEALTHCARE

All healthcare activities carry a carbon liability, from the energy consumed within the sector's buildings, to the vehicles used to transport patients, staff, and visitors, and the products and services used to facilitate its operations. Broadly speaking, these emissions can be divided into two categories: those it can *control*, and those it can *influence*. Expressed using the Greenhouse Gas Protocol's (GHGP) emissions categorisation (Figure 1), emissions from scopes 1 and 2 are considered to be within the sector's control, whilst emissions from scope 3 would attract a more limited level of control and may require more reliance on influence.

Figure 1: Greenhouse Gas Protocol Scopes 1, 2, and 3. (Source: Health Care Without Harm)

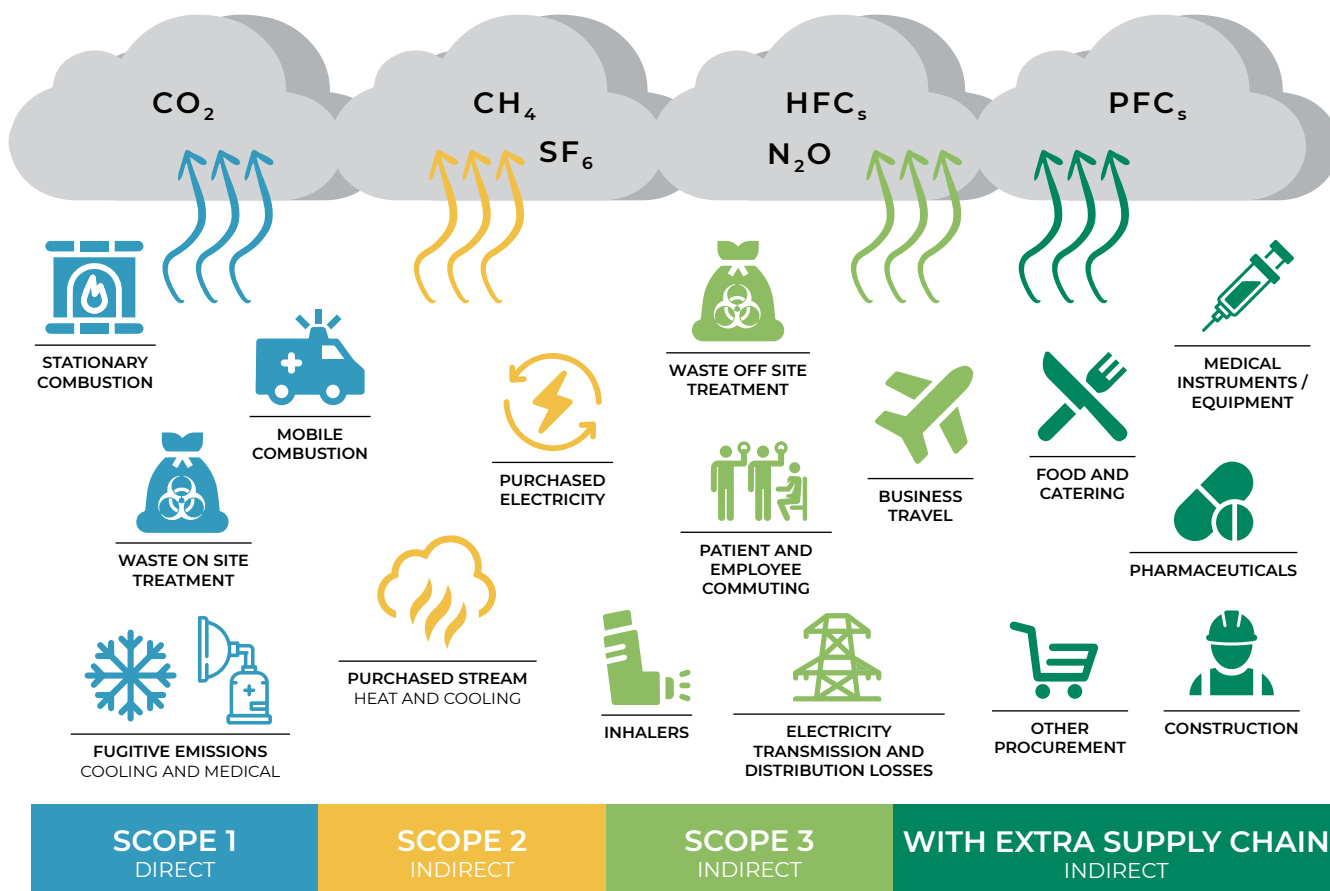

Global healthcare emissions total 2.0 gigatonnes of carbon dioxide equivalent (GtCO₂e). [Figure 2](#) provides a breakdown of these emissions by GHGP scope. Although almost 30% of emissions are generated from either the direct burning of fossil fuels or the purchase of electricity, heat, or steam (scopes 1 and 2), the majority of emissions lie within scope 3, i.e. indirect emissions that are considered outside the direct control of the healthcare sector. This includes emissions from healthcare's global supply chain.

Figure 2: Global healthcare footprint split according to GHGP Scopes. (Source: HCWH Green Paper 1)

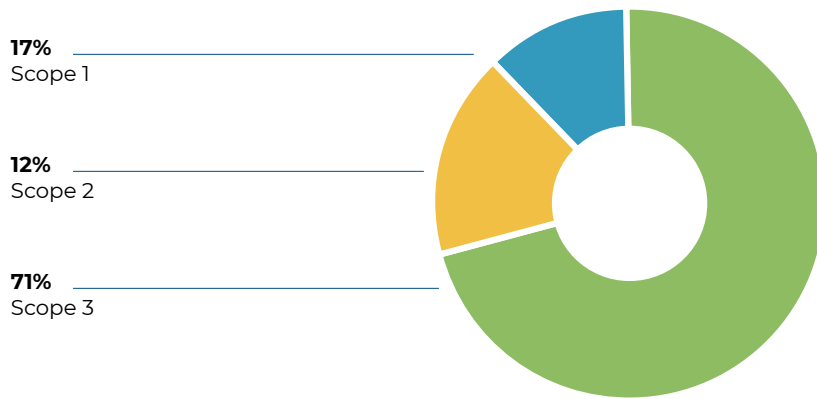

Scope 3 emissions can be broken down further to provide additional detail on emissions sources within the supply chain. [Figure 3](#) shows the top three sources of supply chain emissions: pharmaceuticals, business services, and food, catering, and accommodation.

Figure 3: Healthcare's global emissions by supply chain categories

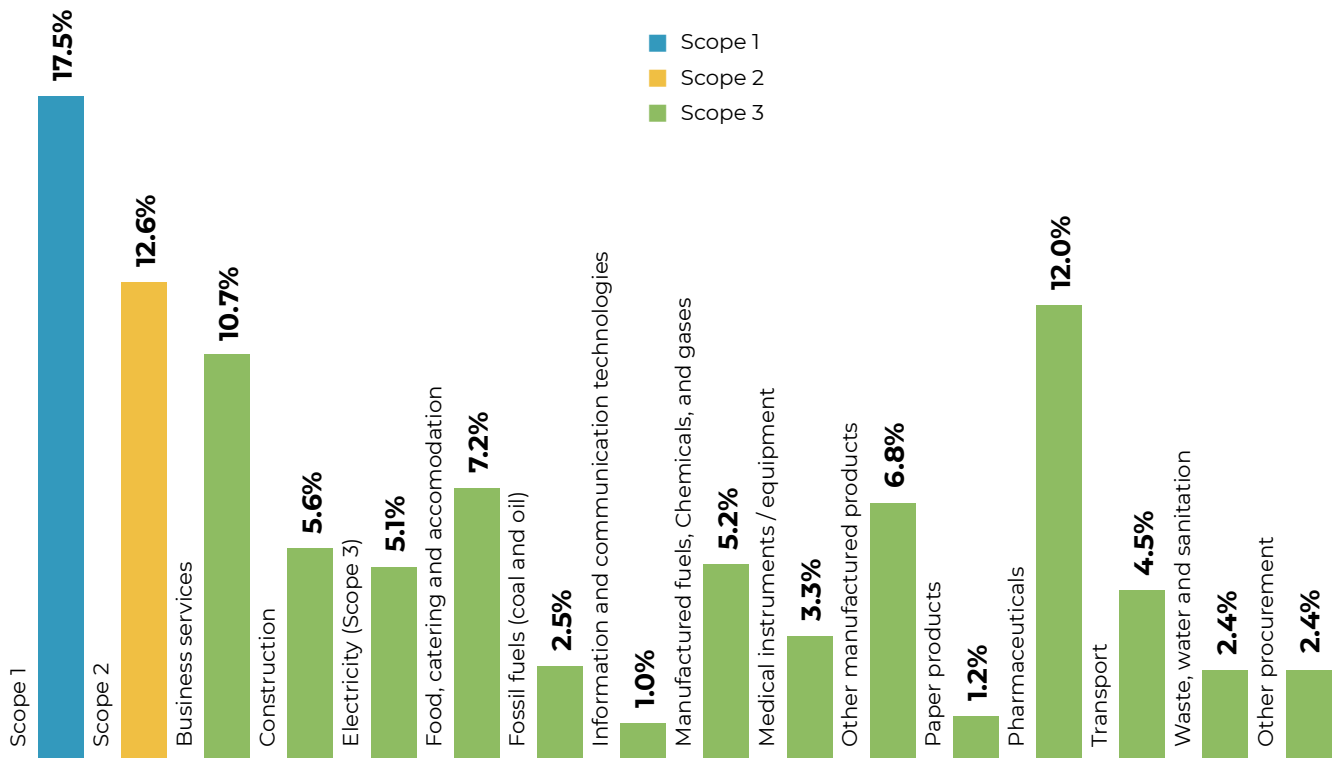

There are significant challenges in accounting for and managing scope 3 emissions, particularly with regards to accessing reliable data (the bed rock to understanding how to intervene for emissions reduction). But, given its significance in the overall carbon footprint, it is vital for healthcare to account for all emissions across all scopes associated with its operations.

1.4 HEALTHCARE-SPECIFIC EMISSIONS SOURCES

Many of the emissions associated with healthcare are common across many sectors and organisations, such as energy consumption, transport, and waste generation. There are, however, additional sources of emissions that are unique to the healthcare sector, notably anaesthetic gases and metered dose inhalers (MDIs). Generally, these gases represent a small but important proportion of total healthcare emissions (approximately 5% of emissions in the National Health Service (NHS) in England, for example), and present a challenge when calculating healthcare emissions at a national or regional level.

Calculating a national or regional carbon footprint from healthcare will likely rely on the use of Environmentally Extended Input Output (EEIO) modelling (see Section 5.4). However, due to the unique nature of anaesthetic gas and MDIs, these sources fall outside these models. Activity level data is therefore required to supplement such a model and provide a comprehensive emissions inventory.

Many of the gases used in anaesthetics and MDIs carry a high global warming potential and have a significant impact on the environment. Despite the challenges in data collection, it is vital that these emissions are included in any healthcare carbon footprint, where possible.



1.5 THE PROCESS FOR CREATING A ROADMAP FOR HEALTHCARE SYSTEM DECARBONISATION

This Methodology provides the process and the component parts for establishing a decarbonisation roadmap for healthcare systems. Methods were developed to align with the principles set out in the Paris Agreement. [Figure 4](#) sets out the overall structure of the roadmapping process, including section numbers for each step. Full method descriptions can be found in the referenced sections of this Methodology. Furthermore, each section of this Methodology concludes with a table to summarise its key outputs. A comprehensive list of all outcomes can be found in Appendix B.

Figure 4: Overarching structure of the roadmapping process, covering the steps detailed in this Methodology. The numbers cross reference to the numbered sections in this Methodology.

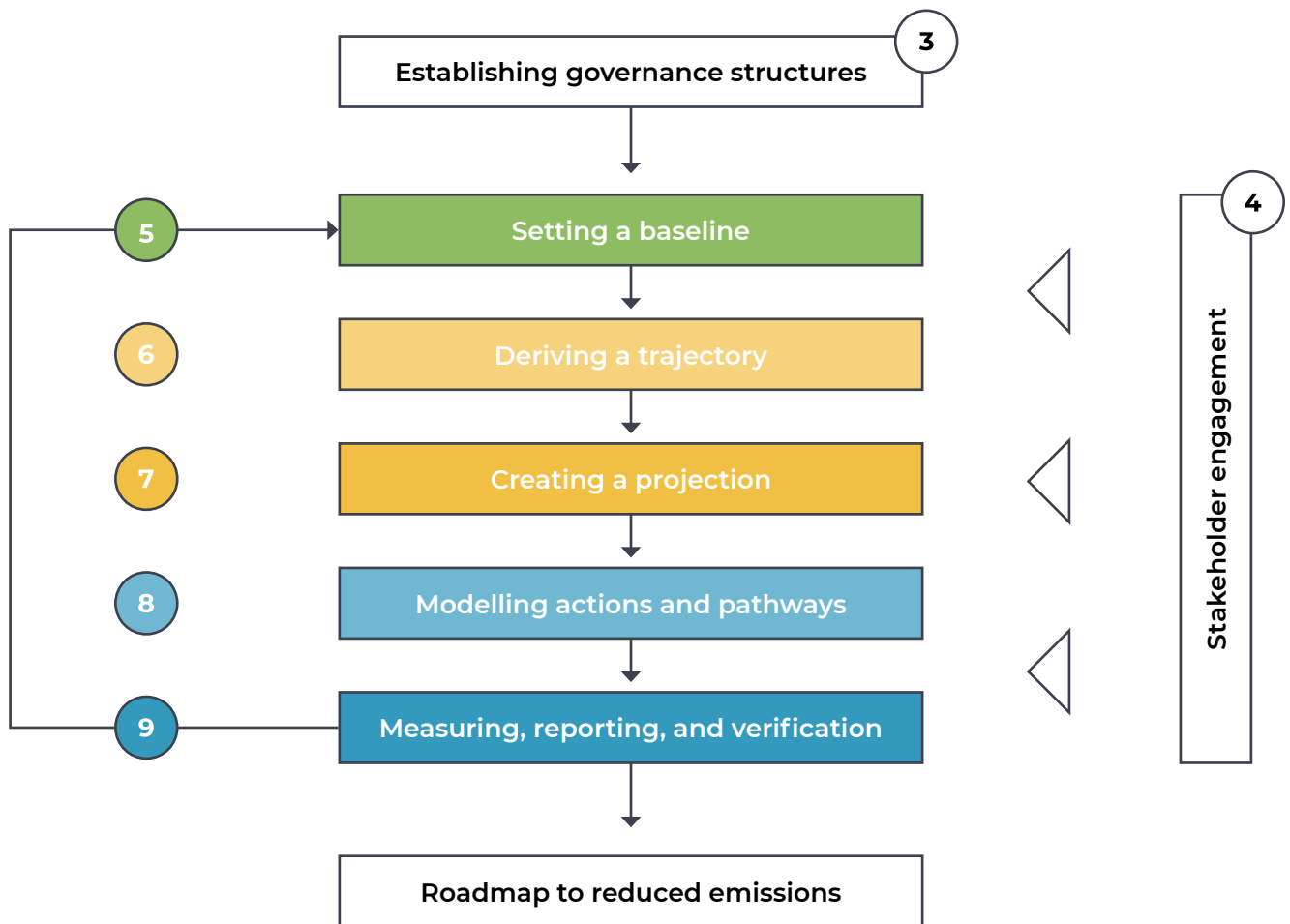

TERMS AND DEFINITIONS



Concordance-based approach

A method widely applied in Environmentally Extended Input-Output (EEIO) models for transposing data from one categorisation system to another using mapping tables known as concordance matrices. Alignment between sector definitions is indicated within the table and this grid is used to redistribute data according to a desired set of category definitions.

Baseline

A detailed assessment of the health sector emissions for the defined geographical scope, covering the core components of the footprint as defined in this Methodology. This baseline provides the basis for future projections and the quantification of emissions mitigation measures.

Decarbonisation/emissions reduction trajectory

Decarbonisation is the process of reducing carbon emissions released. This follows an emissions reduction trajectory depending on ambitions and goals, e.g. aligning with the Paris Agreement.

Emissions boundary

GHG accounting and reporting boundaries can have several dimensions, such as organisational, operational, geographic, business unit, and target boundaries. The inventory boundary determines which emissions are accounted and reported by the entity.³

³ WBCSD, WRI. (2004). A Corporate Accounting and Reporting Standard Revised Edition. Retrieved from The Greenhouse Gas Protocol: ghgprotocol.org/sites/default/files/standards/ghg-protocol-revised.pdf



Emissions intensity

Emission intensity describes the rate of emission for a given pollutant, such as CO₂ relative to the intensity of a specific activity. For example, grams of carbon dioxide released per megajoule of energy produced, or the ratio of GHG emissions associated with the production of a product to expenditure on the finished product.

Two types of emissions intensities are discussed in this Methodology:

- Direct emissions intensity – the emissions emitted by a sector associated with producing a unit of output, such as dollar value of product or service sold to consumers.
- Total emissions intensity – all emissions associated with producing a unit of output, such as dollar value of product or service sold to consumers. This includes emissions from the producing sector's upstream supply-chain that occur due to the demand for goods and services from which sector outputs are produced.

Life Cycle Assessment

A Life Cycle Assessment (LCA) is the compilation and evaluation of the inputs, outputs, and the potential environmental impacts of a product system.⁴ As such, an LCA will tend to consider emissions from the initial extraction of raw materials, its production, and all the way through the product systems life to its end of life.

Input-Output Analysis

Input-Output Analysis (IOA) is the process of manipulating Environmentally Extended Input-Output (EEIO) models to produce insights on resource use and evaluate links between economic consumption activities and environmental impacts.

Greenhouse Gas Protocol: guidance and scope of emissions.

The Greenhouse Gas Protocol (GHGP) is an internationally recognised body of standards for the accounting and reporting of GHG emissions in a range of different settings, e.g. products, organisations, cities, and across different boundaries of assessment, i.e. scope 1, 2, and 3 categories.³ The three scopes as defined by the GHGP are:

- Scope 1: Direct GHG emissions occur from sources that are owned or controlled by an organisation. For example, emissions from combustion in owned or controlled boilers, furnaces, vehicles, etc.; emissions from chemical production in owned or controlled process equipment.
- Scope 2: Indirect GHG emissions from the generation of purchased energy consumed by an entity. Purchased energy is defined as electricity or heat that is purchased or otherwise brought into the organisational boundary of the entity. Scope 2 emissions physically occur at the facility where the electricity or heat is generated.
- Scope 3: These indirect emissions are a consequence of the activities of the entity but occur from sources not owned or controlled by that entity. Some examples of scope 3 activities are extraction and production of purchased materials, transportation of purchased fuels, and use of sold products and services.

⁴ ISO. (2006). ISO 14040:2006 - Environmental management — Life cycle assessment — Principles and framework. Retrieved from International Organization for Standardization: www.iso.org/standard/37456.html

Healthcare

The World Health Organization (WHO) defines healthcare as: “all organisations, institutions, and resources that are devoted to producing health actions”.

Categorisation of healthcare activities

The Organisation for Economic Co-operation and Development (OECD) System of Health Accounts (SHA) has three categorisations for healthcare:

- Healthcare by function – the health system is comprised of activities performed by individuals and institutions pursuing health-related goals. A breakdown of these goals is given in the OECD SHA.⁵
- Healthcare service provider industries – the health system is broken down into institutional categories that produce or provide healthcare services, both primary and secondary.
- Sources of funding healthcare – health system expenditure is allocated to different sources of funding across governments and the private sector.

Primary healthcare provider industry

Primary providers are those whose principal activity is to deliver healthcare goods and services. Typical primary providers are offices of general and specialised physicians, units of emergency ambulance services, and acute and psychiatric hospitals.⁵

Secondary healthcare provider industry

Secondary healthcare providers are those that deliver healthcare services in addition to their principal activities, which might be partially or not at all related to health.⁵

Materiality

A measure of importance to the study determined through different metrics. For example, PAS 2060:2014 describes materiality as “Making significant contribution to the outcome”. PAS 2050:2011 describes materiality as “contribution from any one source of GHG emissions of more than 1% of the anticipated total GHG emissions associated with the product being assessed”, to ensure that very minor sources of life cycle GHG emissions do not need to be considered in the quantification.

Environmentally Extended Input-Output databases

Input-Output (IO) tables model the economic flows between sectors in an economy. Environmentally Extended Input-Output (EEIO) tables combine this with emissions data to quantify links between economic activity and issues such as resource use, land demand, greenhouse gas emissions, etc. EEIO tables can relate to a single country or region or cover multiple regions with many covering the global economy.

⁵ OECD. (2011). A System of Health Accounts. Retrieved from www.who.int/health-topics/health-accounts#tab=tab_1

Economic sector

A description of economic activity captured in modelling, usually derived from the sectors used in EEIO databases. Each sector represents a grouping of similar economic activities. These sector definitions are often tied to published classification schemes, such as the International Standard Industrial Classification (ISIC)⁶ and are well documented.

Net zero

Net zero carbon emissions are achieved when anthropogenic GHG emissions are balanced globally by anthropogenic carbon removals over a specified period.⁷

Carbon offsetting

GHG emissions can be offset using credits from projects that result in carbon reduction or removal. Carbon offsets are acquired to compensate for greenhouse gas emissions arising from a defined subject. Offsets are calculated relative to a baseline that represents a hypothetical scenario for what emissions would have been in the absence of the mitigation project that generates the offsets. A carbon credit is a generic term to assign a value to the carbon offset. One carbon credit is usually equivalent to one tonne of carbon dioxide.⁸

Zero-leakage

A zero-leakage GHG emissions accounting methodology is an approach that successfully captures all sources of emissions within the study boundary conditions.

Top-down

Top-down emissions calculation methods use Input-Output Analysis (IOA) to couple expenditure data with global models of the economy and resource use (known as Environmentally Extended Input-Output, or EEIO, models) to produce an estimate of the share of overall emissions that an entity is responsible for.

Bottom-up

Bottom-up emissions calculation methods use reported data relating to an entity's consumption coupled with activity emission factors to estimate emissions.

Hybrid

A combination of top-down and bottom-up methodologies that combines the benefits of both. Bottom-up is used where robust data is available and to supplement elements that may not be present in the EEIO model. This allows for maximum coverage, while using the highest resolution data available.

⁶ United Nations. (2008). International Standard Industrial Classification of All Economic Activities Revision 4. Retrieved from UN Statistics Division: unstats.un.org/unsd/publication/seriesm/seriesm_4rev4e.pdf

⁷ IPCC. (2019). Refinement to the 2006 IPCC Guidelines for National Greenhouse Gas Inventories. Retrieved from Task Force on National Greenhouse Gas Inventories: www.ipcc-nggip.iges.or.jp/public/2019rf/index.html

⁸ PAS 2060 - Carbon Neutrality Standard and Certification | BSI ([bsigroup.com](https://www.bsigroup.com))



ESTABLISHING GOVERNANCE STRUCTURES FOR DECARBONISATION

Clear and effective governance provides the vital link between developing a strategy and delivering it. Political and administrative structures and approaches to implementation vary significantly between countries and systems, so there is no 'one size fits all' approach. For example, some governments may regulate over incentivise, whilst others may adopt a collaborative over authoritative approach. It is important, therefore, to develop a bespoke approach to governance that fits the national or regional context. This section sets out the steps required to achieve this.

3.1 UNDERSTAND THE STRUCTURE OF THE HEALTHCARE SECTOR

Establishing an accurate understanding of how the national or regional healthcare sector is structured is a key starting point. This will include understanding the public-private split, how it is financed, and how legislation and regulation is developed and implemented.

3.2 IDENTIFY KEY STAKEHOLDERS

This topic is covered in more detail in Section 4. A national or regional healthcare decarbonisation roadmap cannot be delivered by any single organisation - it requires input, commitment and cooperation between various organisations and individuals. Identifying who the key stakeholders are and their level of interest and influence will allow the practitioner to determine who should be included within the chosen governance structure. Stakeholders are likely to be numerous, ranging from public departments and committees, healthcare providers, regulatory agencies, other external public agencies, and the private sector.

3.3 MAP EXISTING POLICIES AND THEIR SUPPORTING STRUCTURES

Appropriate policies (guidance, legislation, regulation, incentives, etc.) will be critical in the successful delivery of the decarbonisation roadmap. Understanding what policies already exist within this sphere, and their supporting structures, e.g. delivery bodies, committees, will allow the practitioner to analyse the strengths and weaknesses of the policies and assess what improvements and additions are needed.

3.4 MAP EXISTING STRUCTURES AND NETWORKS

Depending on the maturity of delivering climate-smart healthcare in the country or region, there may be existing structures or networks in place, e.g. a regional healthcare sustainability practitioners' network. Mapping these will allow the practitioner to capitalise on existing resources and knowledge, which will be critical in achieving decarbonisation ambitions.

3.5 DEVELOP A GOVERNANCE STRUCTURE

Undertaking the above steps will allow the practitioner to establish a baseline for the governance structure. From there, the practitioner can assess strengths and weaknesses, identify gaps and propose new elements, all with the ultimate aim of supporting decarbonisation ambitions. The practitioner can also make critical decisions about roles, responsibilities, and ownership. For example, who will be responsible for providing advice, technical support, measuring and evaluation, etc.

3.6 INCLUDE A PROCESS OF CONTINUOUS IMPROVEMENT

Delivery of a roadmap is unlikely to remain static through time and will need revision as organisations and policies change. It is therefore vital to include a process of continuous improvement when developing and implementing a governance structure. Through this, the practitioner can ensure that governance structures will remain flexible, efficient, and effective during periods of change.

3.7 OUTCOMES FROM THIS SECTION

The steps described in this section should allow the milestones on the roadmap process described in [Table 2](#) to be achieved.

Table 2: Outcome of processes covered in this section.

Roadmap component	Description of outcomes
3.1 Understand the structure of the healthcare sector 3.2 Identify key stakeholders 3.3 Map existing policies and their supporting structures 3.4 Map existing structures and networks	Clear understanding of the structure of the healthcare system established, key stakeholders identified, and existing policies and relevant structures mapped.
3.5 Develop a governance structure	Strengths and weaknesses of existing structures assessed, gaps identified, and new measures identified and implemented.
3.6 Include a process of continuous improvement	Continuous improvement process developed and implemented.





IDENTIFYING AND MANAGING STAKEHOLDERS

Developing a carbon footprint and decarbonisation roadmap for a national or regional healthcare system will require significant input from a wide range of stakeholders. A robust approach in identifying, engaging with and managing these stakeholders is vital. Broadly, stakeholders will vary depending on the following factors:

- Type of organisation: For example, whether the practitioner is from a regional or national government, or a public agency tasked with overall administration of healthcare in the geography.
- Governance structure (Section 3): Whether an authoritative approach is adopted or something more collaborative will have a significant bearing on when and how the practitioner engages with relevant stakeholders.
- Stage of roadmap development: The practitioner will need to engage with different stakeholders at different stages, which may in turn impact on the techniques adopted. For example, the practitioner's focus during the carbon footprinting stage may be on internal stakeholders. This may then shift to external stakeholders during carbon hotspot analysis and pathway modelling.

This section provides the general steps required to effectively identify and manage stakeholders and offers several techniques that may be adopted.

4.1 DEFINE INTERNAL AND EXTERNAL STAKEHOLDERS

The first step in establishing an effective stakeholder engagement strategy is to define which stakeholders are internal and which are external. In many instances, this may be obvious. For example, a privately-run supplier of medical devices will more than likely be considered an external stakeholder. In some instances, however, this may be less clear, particularly within the public healthcare sector. The definition of internal will likely be guided by the practitioner's specific organisation and the governance approach adopted.

For example, internal stakeholders could be considered as other departments within the practitioner's own organisation or other public organisations could be considered as internal, particularly where a partnership approach has been adopted.

Study practitioners should set a clear boundary around internal stakeholders. This should then help define external stakeholders.

4.2 MAP STAKEHOLDERS AGAINST STAGES OF DEVELOPMENT

The next step is to identify and map key stakeholders against each stage of the carbon footprint and decarbonisation roadmap development. This can be done as follows:

- Chart each development stage, e.g. data collection, analysis, carbon footprinting, hotspot identification, pathway modelling, of the roadmap project against a clear timeline.
- List all relevant internal stakeholders against each stage.
- List all relevant external stakeholders against each stage.

It is important to highlight that the practitioner may be unable to identify and map every stakeholder during this step. For example, it may not be possible to identify the stakeholders most relevant to carbon hotspot categories until the relevant emissions categories have been determined. Stakeholder identification and mapping should be considered a dynamic process and the practitioner should periodically return to this step throughout the development of the roadmap to ensure the stakeholder list is updated and remains relevant.

4.3 ORGANISE AND PRIORITISE STAKEHOLDERS

When reviewing the list of stakeholders, the practitioner should consider:

- Who will be helpful to and who will hinder the work?
- Who will champion the work, who will oppose it, and who is indifferent?
- What is the current level of engagement of each stakeholder, and where should they be?
- What interest and influence do stakeholders have?
- How should each stakeholder be engaged with, i.e. should they be consulted, informed, give approval, or perform activities?

Answering these questions for each stakeholder will offer better insight on who to engage with, as well as when and how to do it. The practitioner can then use additional techniques, either in isolation or in combination, to delve deeper, such as:

- Interest-influence matrix: This is a useful tool to support and prioritise stakeholder engagement. In its basic form, it can be used to map stakeholders on a 2x2 matrix. On the horizontal axis, the level of interest is charted, increasing left to right, and on the vertical axis the level of influence is charted, increasing bottom to top (Figure 5). This enables the practitioner to understand how best to engage with each stakeholder group.
- Mapping by issue: This is a useful approach to tailor and refine communications to stakeholders more effectively. It is particularly relevant once healthcare emissions categories have been confirmed and carbon hotspots are being identified. Adopting this technique will facilitate grouping of stakeholders (particularly external) according to emissions categories, e.g. the purchase of energy, pharmaceuticals, and medical devices.
- Tiered system: With this technique, each stakeholder is mapped to tier 1, 2, or 3 based on engagement status. Tier 1 is the most engaged and tier 3 is the least engaged. The process for this mapping can be as subjective or objective as appropriate.

Figure 5: Example stakeholder interest-influence matrix

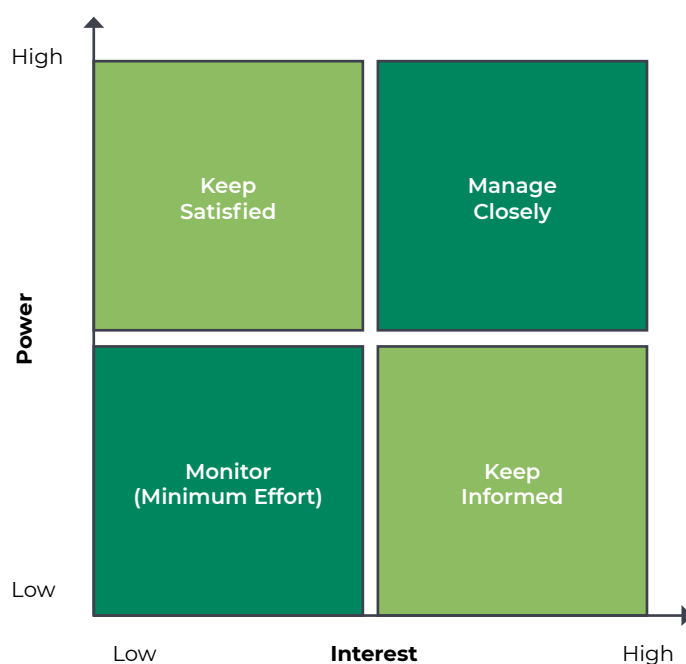

4.4 DEVELOP A STAKEHOLDER ENGAGEMENT STRATEGY

Once the practitioner has identified and mapped key stakeholders, it is advisable to develop a strategy on how best to engage with them. Ideally, this strategy will provide a baseline of current stakeholder engagement, as well as where they should be. It should also provide guidance on the best forms of communication to be used, e.g. personal engagement, or simply kept informed via newsletters/bulletins. Adopting a stakeholder engagement strategy whilst developing a healthcare carbon footprint and roadmap will help to ensure that all members of the team are working towards the same goals.

4.5 MEASURE AND MANAGE STAKEHOLDERS

Stakeholders continually evolve, and how they might interact with the roadmap work may change over time. Stakeholder engagement is a living process that should be continually reviewed and updated as time progresses. It is important to record all engagements and track how stakeholders change over time.

4.6 OUTCOMES FROM THIS SECTION

The steps described in this section should allow the milestones on the roadmap process described in [Table 3](#) to be achieved.

Table 3: Outcome of processes covered in this section

Roadmap component	Description of outcomes
Stakeholder engagement strategy	Stakeholders defined, identified, and mapped against stages of project development, as well as prioritised using appropriate techniques. Stakeholder strategy developed, and stakeholders managed and monitored.





SETTING A BASELINE

This section covers the methodology for setting a baseline emissions inventory from which progress towards decarbonisation can be tracked. The method here starts with identifying which emissions to include in the baseline by defining study scope. Definition is achieved through setting boundary conditions, including for the supply chain and for different healthcare activities. Guidance on how to choose a baseline year and study period is also given. A description of three calculation methods is included (bottom-up, top-down, and hybrid), with information on datasets and emissions sources. Finally, there are sections describing reporting frameworks that can be used to categorise emissions and information around data quality principles.

Figure 6 shows a simplified process of producing an emissions inventory. The structure of this section follows this workflow.

Figure 6: Workflow for setting a baseline.

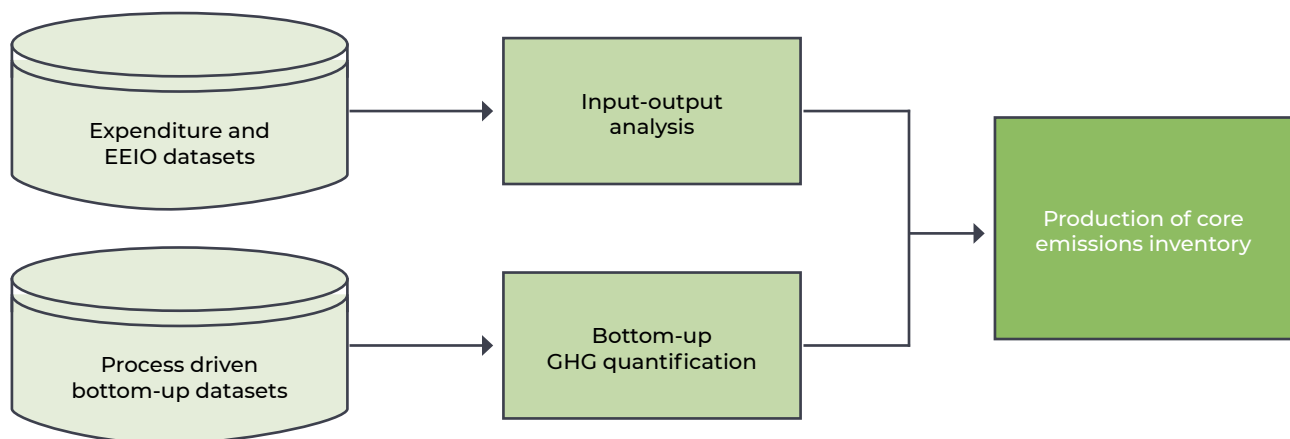

5.1 STUDY BOUNDARY CONDITIONS (SCOPE)

The system boundary defines all the activities whose emissions inventory will be included in the baseline. There are three components for which the boundary should be clearly defined:

- **Supply chain:** working down through a health system's supply chain to define how far into the supply chain emissions are being estimated.
- **Healthcare activities:** working across a health system's breadth of activities to define which organisations, activities, and services are included.
- **Geography:** the nation or region within which healthcare services are being provided, and which is to be footprinted according to this Methodology. When footprinting at the subnational scale, care needs to be taken to ensure input inventory data, e.g. expenditure, matches the boundaries of the region.

5.1.1 Supply chain

The Greenhouse Gas Protocol (GHGP) corporate reporting standard⁹ is recommended for defining the scope of the supply chain, providing a globally recognised and widely used framework for defining supply chain system boundaries. For example, the GHGP defines scope 1, 2, and 3 emissions categories along with subcategories and boundary conditions for organisational inventories and is appropriate for health system assessments. A comprehensive emissions inventory should cover all three scopes and include consideration of imported as well as domestically generated emissions.

Top-down zero-leakage methods based on EEIO databases do not need to set materiality thresholds for the supply chain components scoped into the assessment. This is because the models are boundary free when it comes to supply chain interconnection. However, bottom-up methods should consider materiality levels because of the different boundary conditions that may exist in the emissions factors used by the study. To judge levels of materiality, an estimate of the entire emissions inventory within the chosen boundary conditions will be needed. This can be challenging when undertaking a whole healthcare sector inventory. Study practitioners are free to define their own materiality thresholds but should report and be transparent about these and the choices made in arriving at them.

5.1.2 Healthcare activities

Institutional, funding, and service provision arrangements for providing healthcare vary from country to country. Each national healthcare inventory must therefore define the system boundary around which institutions and services are to be included. Countries may have different definitions of the core elements of the health system, which should be acknowledged when setting a study boundary around activities. However, for meaningful comparisons, there are some elements that should be commonly considered in an emissions inventory.

One consistent method for defining healthcare activities is provided by the System of Health Accounts (SHA).¹⁰

9 WBCSD, WRI. (2004). A Corporate Accounting and Reporting Standard Revised Edition. Retrieved from The Greenhouse Gas Protocol Chapter 3 – Setting Organizational Boundaries; Chapter 4 – Setting Operational Boundaries: ghgprotocol.org/sites/default/files/standards/ghg-protocol-revised.pdf

10 OECD. (2011). A System of Health Accounts. Retrieved from www.who.int/publications/i/item/9789240042551

The SHA provides three taxonomies covering:

- Healthcare activities;
- Financing schemes;
- Functions and providers.

The providers' taxonomy provides the closest match to the institutional arrangements in most countries, and so is suggested as a common method for defining study boundaries in healthcare systems. To enable comparisons between countries, a shared core scope of healthcare activities to be included inside the study boundary is needed. Practitioners of this method are required to include the activities listed as 'Core' in [Table 4](#), which represent 80% of healthcare expenditure in the OECD countries. Practitioners are encouraged to include as many 'Elective' provider categories as they can, subject to data availability and capacity.

The SHA¹⁰ should be accessed for a full and complete description of definitions for the activity classes and sub-categories described in [Table 4](#). For example, detail on the retailers and activities covered within the "Retailers and other providers of medical goods" can be found within this text.

Table 4: Breakdown of core and elective components of the health system for inclusion in an emissions baseline. Activities are broken down by the International Classification of Health Care Providers (ICHA-HP) codes.

ICHA-HP Code	Activity	Core/elective
HP.1	Hospitals	--
HP.1.1	General hospitals	Core
HP.1.2	Mental health hospitals	Core
HP.1.3	Specialised hospitals (other than mental health hospitals)	Core
HP.2	Residential long-term care facilities	--
HP.2.1	Long-term nursing care facilities	Elective
HP.2.2	Mental health and substance abuse facilities	Elective
HP.2.9	Other residential long-term care facilities	Elective
HP.3	Providers of ambulatory healthcare	--
HP.3.1	Medical practices	Core
HP.3.1.1	Offices of general medical practitioners	Core
HP.3.1.2	Offices of mental medical specialists	Core
HP.3.1.3	Offices of medical specialists (other than mental medical specialists)	Core
HP.3.2	Dental practice	Core
HP.3.3	Other healthcare practitioners	Core

ICHA-HP Code	Activity	Core/elective
HP.3.4	Ambulatory healthcare centres	Core
HP.3.4.1	Family planning centres	Core
HP.3.4.2	Ambulatory mental health and substance abuse centres	Core
HP.3.4.3	Free-standing ambulatory surgery centres	Core
HP.3.4.4	Dialysis care centres	Core
HP.3.4.9	All other ambulatory centres	Core
HP.3.5	Providers of home healthcare services	Core
HP.4	Providers of ancillary services	--
HP.4.1	Providers of patient transportation and emergency rescue	Elective
HP.4.2	Medical and diagnostic laboratories	Elective
HP.4.9	Other providers of ancillary services	Elective
HP.5	Retailers and other providers of medical goods	--
HP.5.1	Pharmacies	Core
HP.5.2	Retail sellers and other suppliers of durable medical goods and medical appliances	Core
HP.5.9	All other miscellaneous sellers and other suppliers of pharmaceuticals and medical goods	Core
HP.6	Providers of preventative care	Elective
HP.7	Providers of healthcare system administration and financing	--
HP.7.1	Government health administration agencies	Elective
HP.7.2	Social health insurance agencies	Elective
HP.7.3	Private health insurance administration agencies	Elective
HP.7.9	Other administration agencies	Elective
HP.8	Rest of economy	
HP.8a	Households as providers of home healthcare	Elective
HP.8b	All other industries as secondary providers of healthcare	Elective
HP.8c	Other industry	Elective
HP.9	Rest of the world	Elective

There are four additional areas of healthcare systems' emissions that merit specific consideration (see [Table 5](#)).

Table 5: Four areas of healthcare systems' emissions meriting specific consideration.

Activity	Description	Core/elective
Patient travel	Patient travel to/from healthcare appointments and treatment sessions. Expenditure data sits outside the health system and is not accounted for in the SHA. Considered in the GHGP to be part of scope 3 of an organisation's footprint.	Elective
Staff travel	Healthcare staff travel to/from work. Expenditure data sits outside the health system and is not accounted for in the SHA. Considered in the GHGP to be part of scope 3 of an organisation's footprint.	Elective
MDIs	The gases used within the product are greenhouse gases. Expenditure data sits under <i>HP.5 Retailers</i> if patient procured. Considered in the GHGP to be scope 3 for the manufacturer, outside the health organisation's footprint.	Core
Anaesthetic gases	The gases themselves are greenhouse gases. Expenditure data will sit under whichever provider category the purchasing health organisation sits. Considered to be scope 1 in the GHGP.	Core

5.2 BASELINE YEAR AND STUDY PERIOD

A baseline year should be chosen from which to compile the healthcare system emissions inventory. This will act as a reference year against which future emissions estimates can be benchmarked, as part of the roadmapping process.

The baseline year should be the most recent year for which all necessary data is available. This will give study practitioners the most up to date information about near term outturn emissions and a clear reference point from which to examine a net zero decarbonisation goal. The baseline year should be clearly referenced alongside any assumptions or modelling approaches that have been used to fill data gaps.

The study period is the period of time over which future emissions estimates are determined, and for which the GHG emissions budget and net zero objective of the roadmap are presented. It is recommended that this is set to achieve the aim of the Paris Agreement of limiting global average temperature rise to no more than 1.5 °C above pre-industrial levels. In line with the IPCC SR15 report (Special Report - Global Warming of 1.5°C),¹¹ limiting warming to 1.5°C implies

¹¹ IPCC. (2018) Global Warming of 1.5°C. An IPCC Special Report on the impacts of global warming of 1.5°C above pre-industrial levels and related global greenhouse gas emission pathways, in the context of strengthening the global response to the threat of climate change, sustainable development, and efforts to eradicate poverty [Masson-Delmotte, V., P. Zhai, H.-O. Pörtner, D. Roberts, J. Skea, P.R. Shukla, A. Pirani, W. Moufouma-Okia, C. Péan, R. Pidcock, S. Connors, J.B.R. Matthews, Y. Chen, X. Zhou, M.I. Gomis, E. Lonnoy, T. Maycock, M. Tignor, and T. Waterfield (eds.)]. In Press.

reaching net zero CO₂ emissions globally around 2050. It is therefore recommended that for the roadmap, the study period is set from the baseline year to the 2050 end point year. It is, however, recognised that different national settings might identify other preferable end point years (either before 2050 or later). For example, to better align with country Nationally Determined Contributions (NDC). If an end point year other than 2050 is selected this should be clearly described together with the justification for the alternative year and subsequent study period.

5.3 CALCULATION METHODS (TOP-DOWN, BOTTOM-UP AND HYBRID)

There are three approaches to calculating components of the healthcare sector's emissions. In this Methodology, they are referred to as top-down, bottom-up, and hybrid methods.

5.3.1 Top-down assessments

Top-down methods combine expenditure data with EEIO databases to create high-level estimates of emissions. Advantages of a top-down method include it being zero-leakage and its ability to footprint activities where bottom-up data may be scarce or incomplete. Disadvantages include the provision of low-granularity outputs (emissions quantified by economic sector, not by specific activity or product) and wide error bounds of the order of +/- 30%. The principal value of a top-down method is that it provides order-of-magnitude assessments of the emissions inventory of large organisations or areas of economic activity, of which national health systems are good examples. The calculation process for producing a top-down emissions baseline for a healthcare system is shown in [Figure 7](#).

Figure 7: Calculation process for production of a top-down emissions baseline.

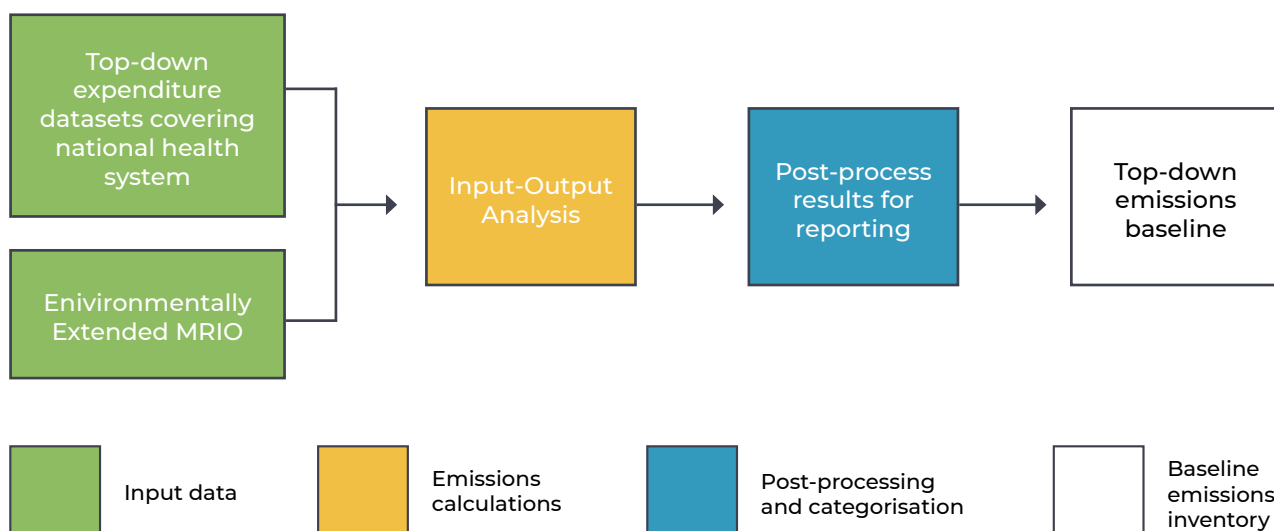

5.3.2 Bottom-up assessments

Bottom-up methods include LCA-based approaches, or more basic emissions estimate approaches that combine reported resource consumption data, i.e. relating to an activity or quantum of product use, with emissions factors associated with those activities. Chapter 6 of the GHGP (Identifying and Calculating GHG Emissions)¹² gives an overview of the process undertaken for a bottom-up assessment, from identifying sources of scope 1, 2, and 3 emissions, to data collection and emissions factors, calculation tools, and finally, rolling up facility-level data to corporation/country-level. Further guidance on the quantification of GHG emissions can be found in ISO standard 14064 (Greenhouse gases) Part 1.¹³

Advantages of a bottom-up method include the provision of highly granular information regarding the footprint of an activity. Disadvantages include the need for more data to complete the assessment, and the increased risk of leakage, i.e. a footprint can be underestimated if the system within a boundary is not fully incorporated, and all relevant data found and applied. An entirely bottom-up approach is not recommended for producing a baseline due to challenges in quantifying all emissions sources across operations and supply-chain sources. Nevertheless, bottom-up data may be used to supplement top-down emissions in a hybrid model to bring enhanced granularity for emissions sources where robust data is available.

5.3.3 Hybrid assessments

A hybrid approach that combines elements of top-down and bottom-up methods to build on their respective advantages can be used to calculate an emissions inventory that is zero-leakage and comprehensive, yet also makes use of activity-specific, granular (bottom-up) data where available.

Here, the specific hybrid approach suggested applies a top-down method to calculate the inventory in activities where more granular bottom-up data is available. In such cases, inventory estimates calculated using bottom-up methods can be substituted for the equivalent activities estimated by the top-down method. Care should be taken to avoid double-counting by deducting the contribution of that activity estimated by the top-down method.

The workflow required to produce a hybrid baseline is shown in [Figure 8](#). This approach ensures full coverage of emission sources in the model, while providing robust estimates for emission sources where reliable process-based datasets are available.



¹² WBCSD, WRI. (2004). A Corporate Accounting and Reporting Standard Revised Edition Chapter 6 – Identifying and Calculating GHG Emissions. Retrieved from The Greenhouse Gas Protocol: ghgprotocol.org/sites/default/files/standards/ghg-protocol-revised.pdf
¹³ ISO - ISO 14064-1:2018 - Greenhouse gases — Part 1: Specification with guidance at the organization level for quantification and reporting of greenhouse gas emissions and removals

Figure 8: Calculation process for production of a hybrid emissions baseline, combining bottom-up quantification of emissions sources where data is available with a top-down model to ensure all emissions sources are captured in the baseline.

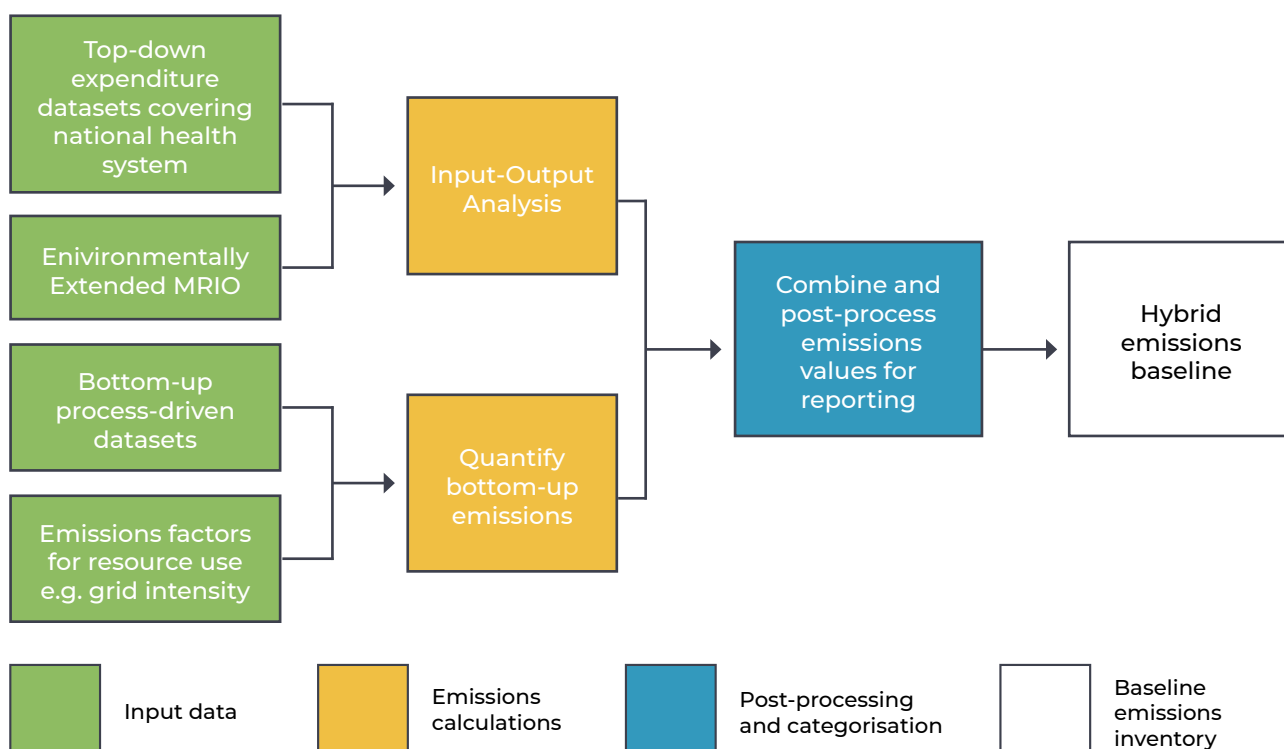

5.3.4 Summary comparison of assessment methods

Table 6 summarises the strengths and weaknesses of the assessment methods.

Table 6: Strengths and weaknesses of approaches

Assessment method	Strengths	Weaknesses
Bottom-up	<ul style="list-style-type: none"> ● Direct data on, for example, fuel use, will give the most accurate emissions values 	<ul style="list-style-type: none"> ● Time intensive to collect data ● Likely to be many gaps and practically impossible to gain coverage over the whole system
Top-down	<ul style="list-style-type: none"> ● Ensuring coverage across the whole healthcare system is more straightforward compared to the bottom-up method ● Less time intensive data collection compared to the bottom-up method 	<ul style="list-style-type: none"> ● Spend-based proxies can only give estimates of emissions values ● Some countries' input-output database data may be less robust than others
Hybrid	<ul style="list-style-type: none"> ● Possible to combine higher accuracy data from bottom-up sources with wider coverage from top-down. Key emissions sources can be targeted for bottom-up calculations where possible. 	<ul style="list-style-type: none"> ● Time needs to be dedicated to ensuring that emissions are not double counted across the two methods

5.4 ESTABLISHING A BASELINE USING A TOP-DOWN METHODOLOGY

Top-down methods of emissions assessment as described here use a zero-leakage methodology based on EEIO databases. In this context, zero-leakage indicates the coverage of the emissions calculation methodology, where all emissions sources associated with a source of expenditure across operations and supply-chain are accounted for in the estimate. These approaches use national and global models of the structure of the economy and direct emissions from individual sectors to estimate the proportion of total emissions being driven by an organisation's expenditure on goods and services. Using these models gives a comprehensive estimate for all emissions associated with an entity, including full supply-chain emissions. However, there are several common assumptions and limitations that come with this approach, briefly summarised below:

- **Homogeneity of product** – the assumption that each sector in the economy produces a single, homogeneous product or service. This means a single emissions intensity value is used for all outputs of a sector, where in reality, a degree of variation between sector outputs exists.
- **Sector resolution** – for some models, the sector resolution at the national level may be low, especially where the underlying national data is sparse.
- **Time series and model year** – different EEIO models are updated over differing timeframes, typically 1-5 years, which can lead to a lag between latest available model year and the present.

5.4.1 Input data

The input data used for a top-down assessment is key to ensuring results of modelling are representative of the entity for which the GHG footprint is being produced. Data should be assessed against quality criteria defined by the study practitioner, covering aspects such as age, geography, reliability, and technology representation. Understanding these factors for a given dataset is key to the calculation process and helps to ensure any limitations arising from source data are known. Guidance around this topic is available in the GHGP.¹⁴

5.4.1.1 Expenditure

The expenditure data sets the scope of the assessment. It should represent all the activities to be included in the baseline. A balance should be found between comprehensiveness and granularity. For example, an individual facility might have highly granular expenditure relating to its activities. The facility might aggregate that data into categories to report expenditure to the local health authority, which would also receive data from similar facilities within its area. Therefore, at the local health authority level, more comprehensive but less granular data would be available. This pattern continues all the way up to countries reporting data to the WHO, the OECD, or similar institution, who provided the highly comprehensive but lower granularity data used in the Global Roadmap.¹⁵

National statistics agencies are involved in compiling tables of expenditure in different economic sectors and will be able to advise on the best available economy-wide data available in a country of assessment. When producing a national healthcare sector inventory, gathering a national

¹⁴ WBCSD, WRI. (2004). A Corporate Accounting and Reporting Standard Revised Edition. Retrieved from The Greenhouse Gas Protocol: ghgprotocol.org/sites/default/files/standards/ghg-protocol-revised.pdf

¹⁵ Health Care Without Harm & Arup. (2021). Global Roadmap for Health Care Decarbonization. Retrieved from Global Roadmap for Health Care Decarbonization: healthcareclimateaction.org/roadmap

expenditure profile for health expenditure should be prioritised as it provides better resolution than globally available data.

GLOBAL SOURCES OF HEALTHCARE EXPENDITURE DATA

Data covering healthcare expenditure is published by the OECD¹⁶ and the WHO.¹⁷

The OECD dataset conforms to the WHO's definition of healthcare and is structured using the System of Health Accounts. The data covers 48 countries from the OECD and others detailing expenditure by health sector activity type and funding mechanism.

The WHO dataset covers 192 countries, detailing expenditure by funding mechanism without providing a breakdown of expenditure type.

As the expenditure determines the scope of the baseline, a clear statement of what activities are covered in the data should be set out. Where expenditure data for a component of the healthcare system is unavailable this should be stated.

Expenditure datasets are unlikely to use the same sector categories as found in the selected EEIO. To use this data within the baseline model, some restructuring is likely required, as detailed in Section 5.4.2.1.

Data covering health expenditure may be taken from either global expenditure datasets, such as those published by the OECD, or from national-level data gathered within the country of assessment. National data may provide greater granularity than global datasets. Care should be taken to ensure that any expenditure data used covers all activities required for the emissions inventory.

When using expenditure data with EEIO databases it is important to ensure that the units match the type of expenditure data included in the EEIO. This relates to currency, but also the type of expenditure measure; whether data is in constant prices or fixed prices; and whether the EEIO model uses basic or purchaser prices. Converting data to adjust for inflation or remove taxes and margins (often included in the value-added block of an EEIO if it is expressed in basic prices), may be needed to align reported health expenditure data with the expenditure information contained in the EEIO.

¹⁶ OECD. (2019). Health spending. Retrieved from OECD Data: data.oecd.org/healthres/health-spending.htm

¹⁷ World Health Organization. (2021). Global Health Expenditure Database. Retrieved from World Health Organization: apps.who.int/nha/database/ViewData/Indicators/en

5.4.1.2 Emissions datasets

EEIO databases cover direct emissions from CO₂ and, in some cases, other GHGs by sector. Through calculations based on EEIO databases, these direct emissions inventories may be used to derive full supply-chain assessments associated with all healthcare system spending. Useful EEIO databases include:

- World Input-Output Database (WIOD)¹⁸
- Global Trade Analysis Project (GTAP)¹⁹
- Eora²⁰
- EXIOBASE²¹

Many individual national EEIOs also exist, and practitioners should investigate the potential to harness the relevant national model for the purpose of assessment.

5.4.2 Calculations

The calculations and data manipulations required to quantify the baseline are described across the following section.

5.4.2.1 Aligning sector expenditure data with a final demand profile for Input-Output Analysis

To generate the emissions inventory associated with the healthcare sector, the expenditure data covering the expenditure on the sector should first be mapped onto the categories used in the EEIO model. A concordance-based approach may be used to undertake this sector mapping. This process maps spending on the healthcare system across sectors that provide healthcare services. Often the sector containing the health system is described as “health and social work” (or similar), though sectors within manufacturing, transport, and waste treatment may also contain some health-specific activities. [Figure 9](#) provides a graphical representation of this process.

The International Standard Industrial Classification (ISIC) is a commonly used categorisation for EEIO tables. It publishes some example concordances between itself and other systems on its website.²²

¹⁸ [World Input-Output Database | WIOD | Groningen Growth and Development Centre | University of Groningen \(rug.nl\)](#)

¹⁹ [GTAP Data Bases: GTAP Data Base \(purdue.edu\)](#)

²⁰ [Eora Global MRIO \(worldmrio.com\)](#)

²¹ [Exiobase - Home](#)

²² ISIC. (2021). UN Statistics Division. Retrieved from ISIC Correspondences: unstats.un.org/unsd/classifications/Econ/ISIC.cshtml

Figure 9: Simplified illustration of the concordance-based approach required to take expenditure from reported categories (left) to categories consistent with the EEIO model (right). The expenditure data captured under a category, such as “hospitals” in financial accounts, may be split across multiple product types and activities as covered in the EEIO categorisation scheme. For clarity, the number of sectors has been reduced in this illustration..

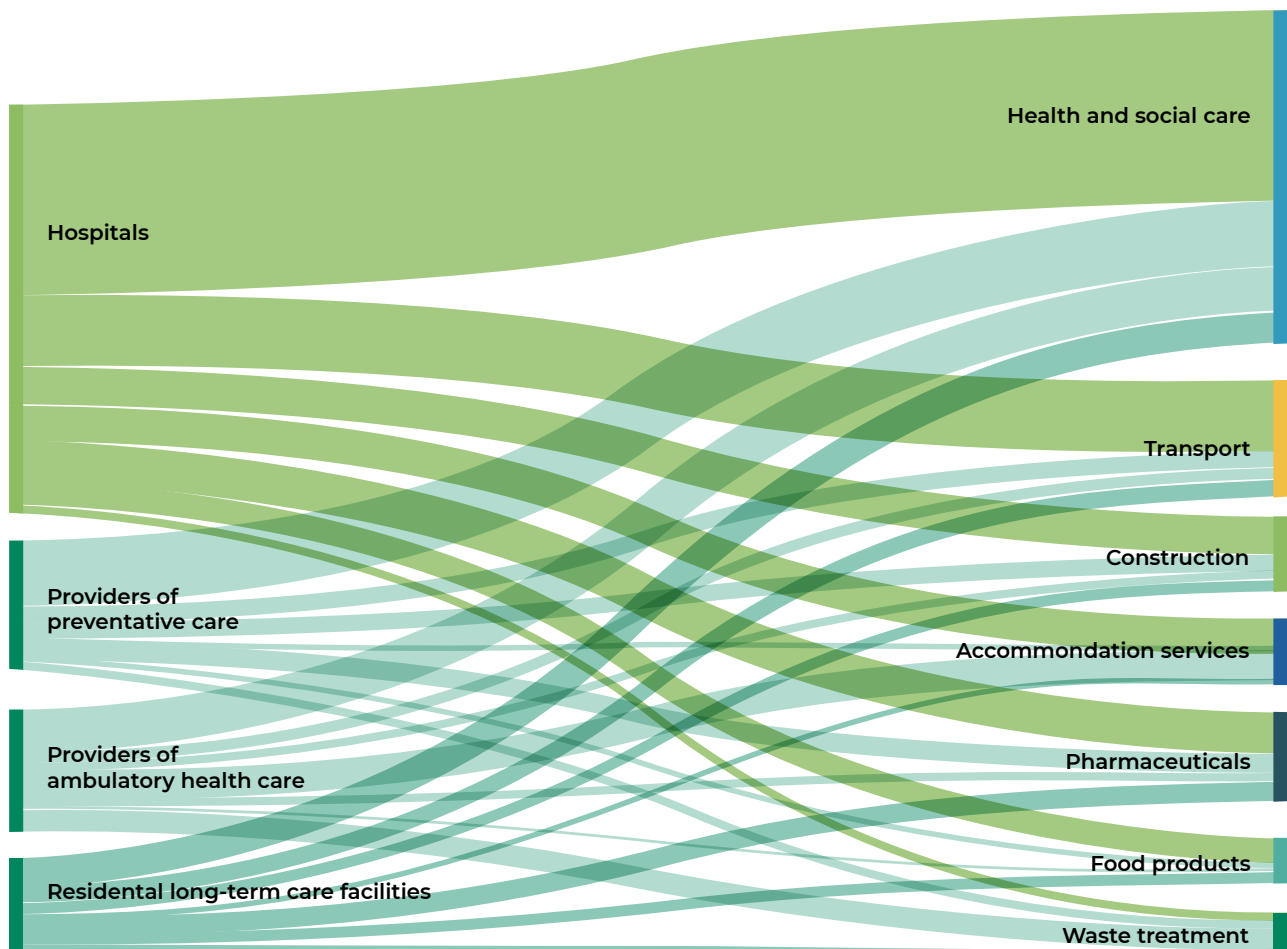

5.4.2.2 Supply-chain contributions

In some instances, a detailed emissions inventory for the healthcare system supply-chain by product category and emissions source is desired. Examples of this would include where scope 1 emissions are to be quantified separately via bottom-up methods, or where greater detail is desired around scope 2 and 3 emissions as part of a purely top-down assessment.

To generate such detailed inventories of supply-chain emissions, an expenditure profile detailing where the health system purchases goods and services is required. This profile can be gathered from financial ledgers compiled across the health system or approximated using an assumed profile taken from a national Supply and Use Tables (SUT), IO table, or global EEIO model.

When selecting an assumed profile, care should be taken to ensure the sector boundary aligns with the definition of the health system selected for the study. If converting a total healthcare expenditure value to an expenditure profile for the sector supply-chain, care should be taken to remove other outgoings, such as employee remuneration.

DERIVING AN ASSUMED PROFILE FOR SUPPLY-CHAIN EXPENDITURE

Where a published expenditure profile is not available for supply-chain expenditure, and the health system is not able to provide a detailed breakdown of expenditure, a profile may be approximated using a total expenditure value, data on employee remuneration for the sector, and a proxy profile derived from national statistics tables, such as an SUT or IO table.

(Total expenditure - employee remuneration) x proxy profile

To ensure the expenditure included in the model represents the sector's activities and supply-chain, money spent on employee remuneration is first subtracted. The remaining expenditure is then split across product categories using a profile taken from an SUT or IO model. The proxy profile should be representative of the expenditure for the healthcare system, taken from a model sector that focuses on the health system without combining health spend with other related sectors. When choosing the profile, the data source should be selected to correspond with the sector categorisation used in the chosen EEIO if possible. Further mapping may be conducted using concordances if necessary.





CASE STUDY:

PRODUCING A DETAILED EMISSIONS INVENTORY FOR THE HEALTHCARE SYSTEM SUPPLY-CHAIN (PORTUGAL)

To produce a detailed supply-chain emissions inventory for the Portuguese health system, the Portugal team calculated the emissions factor of each WIOD sector, starting by defining the direct intensity vector, dividing the emissions data on each sector (obtained from the WIOD/PRIMAP environmental accounts) by the respective WIOD expenditure data, and multiplying this vector by the Leontief inverse matrix.

After that, Portugal mapped the expenditure on the Portuguese health sector (removing the amount spent with wages) onto the WIOD categories using, as a reference, an expenditure profile given by a SUT (Supply and Use Table) for the Portuguese sector “Human health activities”.

Finally, Portugal obtained the supply-chain emissions inventory by multiplying the healthcare expenditure on each WIOD sector by its specific emission factor.



5.4.2.3 Input-Output Analysis to generate an emissions inventory baseline

A top-down emissions baseline for the national health system may be derived through Input Output Analysis (IOA) using EEIO databases and the expenditure profile across supply-chain categories derived from national health expenditure. The mathematics of calculating a baseline is derived from the work of Leontief²³ with the principles and calculation process described in the work of Kitzes.²⁴

An EEIO provides detail on emissions sources as well as the distribution of emissions across the health sector supply chain according to the sector categories in the chosen EEIO. These values may be combined according to sector groupings and the reporting priorities of the practitioner. For guidance around reporting options, please see section 5.6.

5.4.2.4 Post-processing model outputs

The output of methods described through section 5.4 provide the healthcare system's emissions inventory based on the sectors in which the emissions take place and following the naming structure in the chosen EEIO. This is not, however, how many health organisations wish to view their emissions footprint, which is often segmented using taxonomies such as the GHGP. Therefore, further calculations and data manipulations will be needed to express a footprint in this way.

Figure 10: Illustration of main funding flows through the health system, with health system funding shown on the left moving through to the areas in which the system spends on employees, supply-chain, and capital investments.

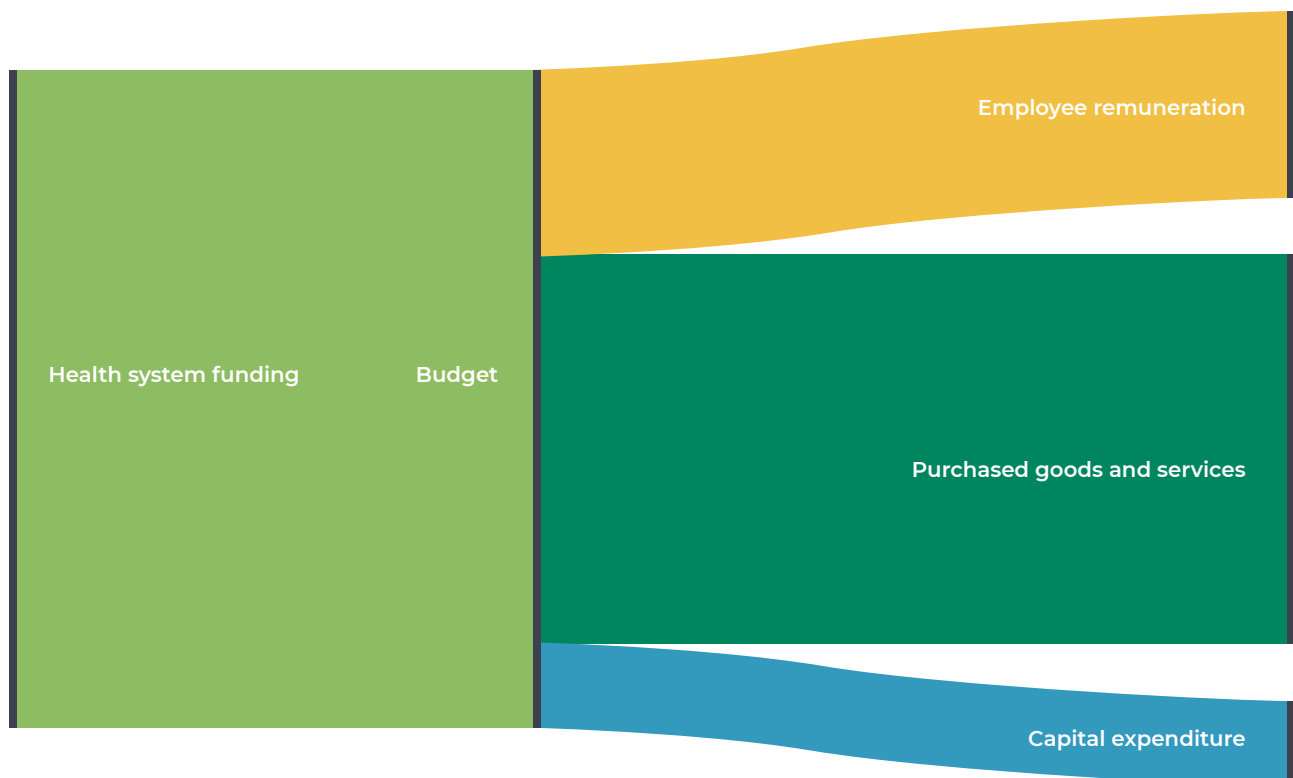

23 Leontief, W. (1936). Quantitative input-output relations in the economic system of the United States. *Rev. Econ. Stat.*, 105-125.

24 Kitzes, J. (2013). An Introduction to Environmentally-Extended Input-Output Analysis. *Resources* (2), 489-503.

The differences in framing and implications for modelling are shown in [Figure 10](#), highlighting the differences between data covering spend on the system versus spend by the system:

- Where expenditure details **health system funding**, scope 1 emissions may be derived through multiplication by the direct emissions intensities of economic sectors this relates to, giving the emissions occurring as a direct result of expenditure on healthcare provision. Here the direct emissions intensity relates to the emissions occurring in the economic sector itself, whereas the overall emissions intensity of a sector includes emissions arising in that sector's supply-chain.
- Where expenditure details spending by the health system **on purchased goods and services or capital expenditure**, the expenditure profile used here details expending on external suppliers by the health sector. This excludes scope 1 emissions and will deliver an inventory of emissions embodied in the goods and services procured by the healthcare system.

The above can have implications on how best to identify the aspects of the overall footprint that relate to each of the emissions scopes as defined in the GHGP. To derive scope 2 and 3 emissions from the total emissions calculated in the inventory, a few calculations are required. Scope 2 emissions should be derived through isolating the direct emissions occurring in the generation of energy procured by the health sector. Having identified scope 1 and 2 emissions, scope 3 emissions then make up the remainder of the footprint.

5.5 INCLUDING BOTTOM-UP DATA TO CREATE A HYBRID MODEL

Where robust, bottom-up, process-based data is available for a healthcare system, e.g. metered data on energy use in buildings, such data can be integrated into an inventory estimate to enhance the baseline. Using such data results in reliable and accurate emissions quantification. However, data collection and harmonisation can be challenging and time-consuming. Combining a top-down estimate based on expenditure and EEIO databases with bottom-up data results in a hybrid model that leverages the benefits of both approaches, ensures full coverage of the sectors emissions whilst capturing the highest resolution data where it is available. To construct a hybrid model whilst avoiding the risk of double-counting, care should be taken to zero elements of the top-down assessment for which bottom-up data is to be used.

Bottom-up data may also be introduced to cover emissions sources outside the EEIO model, such as from anaesthetic gases, depending on the reporting framework selected.

Re-baselining emissions inventories to improve accuracy and increase model resolution can bring benefits around target-setting and progress-tracking. As organisations become more data-rich and the capability to produce bottom-up models evolves, care should be taken to introduce these values into earlier, largely top-down estimates. There is a risk of introducing double-counting or leakage into the baseline at this stage, and it is advised that the areas of expenditure covered by the newly acquired bottom-up data are carefully removed from the top-down calculations. This will ensure that activities not covered in the new datasets are still included in the model.

5.5.1 Input data

Data collection will likely include partners and suppliers both internally and externally with engagement from multiple internal departments, such as procurement, accounts, logistics, medical supplies, transport, facility management, amongst others.

Figure 11: Data hierarchy to adopt when identifying model inputs.



A hierarchy for data preference should be applied, based on emissions hotspots and data quality. The priority should be to utilise direct fuel and energy use data, for example, energy use in kilowatt hours (kWh) from utility bills, or fuel litre and expenditure receipts in high spend categories. Where sector wide data is not available, detailed data with partial sector coverage, i.e. for representative facilities, or a region, may be used if it is assumed they represent the wider sector. In some cases, proxy data and estimates may be used, for example, distance travelled can be used to estimate fuel use if vehicle fleet make up is known. Many emissions factor databases have factors for both.

Where neither the primary nor secondary data is known or possible to obtain, spend-based methods can be used, as described in Section 5.4.

5.5.1.1 Data sources and collection

Practitioners should seek to enhance their baseline inventory by including bottom-up data where it will be useful. This may follow an iterative process that gains wider scope and more detail with time. For example, bottom-up data might first be captured and applied in known emission hotspot categories, such as fuel purchased for stationary energy needs, i.e. combustion onsite. Over time additional datasets covering fuel for vehicles, or weight of waste generated in operations, or electricity purchased from grid, may be added in a bottom-up manner using more detailed and specific emissions factors for these known processes.

Care should be taken when using combinations of bottom-up and top-down data and/or when replacing top-down data with bottom-up data. This is because it can result in a change in reported emissions inventories. This will arise because of differences between the two methods including aspects such as different study boundary conditions, emissions factors that are derived through different impact assessment models, and emissions factors that work at different levels of product aggregation, e.g. a top-down emission factor for 'plastic products' might be applied, whereas a bottom-up factor for 'high density polyethylene' [HDPE] might be available and used instead. Variation in reported emissions inventories due to this should be expected and it is important to be prepared for the change as different datasets and methods are applied. For areas where changes are made, it will be important to anticipate shifts in

reported inventories. It will be important to ensure that stakeholders to the data, e.g. those engaged in working with it on leading climate action programmes, are fully briefed, understand how the changes may have arisen, and can manage any implications.

A list of common emissions sources targeted through a bottom-up approach is given below. This is non-exhaustive, and the selection of bottom-up calculations should be driven by data availability. The HCWH Climate Impact Checkup tool²⁵ supports facility-level recording of this information.

Table 7: Examples of bottom-up data that may be available by GHGP scope and category.

GHGP Scope	GHGP emissions type	Data source example
Scope 1	On-site fuel consumption	kWh usage from natural gas invoices, e.g. hospitals
Scope 1	Fuel use in owned/leased vehicles	Litres of fuel from fuel invoices
Scope 2	Electricity use	kWh usage from electricity invoices
Scope 3	Category 5 – waste generated in operations	Waste tonnage by type/treatment, e.g. paper – recycled
Scope 3	Categories 6 and 7 – business travel and employee commuting	Distance travelled from invoices, travel agents, and surveys

The process of gathering and harmonising bottom-up data sources into an emissions baseline can be time-intensive, and therefore is often limited to key categories where robust data is readily available. By using bottom-up calculations to supplement a top-down assessment, all emissions sources can be represented in the baseline model with greater detail for key emissions sources.

²⁵ *Climate Impact Checkup – Health care’s GHG emissions calculator | Global Green and Healthy Hospitals (greenhospitals.net)*





CASE STUDY:

GATHERING AND HARMONISING BOTTOM-UP DATA INTO AN INVENTORY (THE NETHERLANDS)

A top-down analysis using IOA does not capture all healthcare-related emissions. The main missing emissions sources are emissions from anaesthetic gas releases, MDIs, and, finally, emissions from employee commuting and private trips of patients and visitors. For anaesthetic gases, this is due to incomplete data, as direct carbon emissions for the healthcare sector reported by the statistical office do not include emissions from medical gas releases. The Netherlands National Institute for Public Health and the Environment (RIVM) estimated the impact based on a similar healthcare footprint study conducted for the NHS England. In addition to GHG emissions, they also carried out *further in-depth studies* examining material extraction, blue water consumption, land use, and waste generation. The other missing sources of impact are due to the IOA method, which does not include consumption-based emissions in the calculation of sectoral impacts. For the impact, due to the use of MDIs, the Netherlands were able to combine several freely available data sets to calculate the impact.

For travel emissions, the Netherlands used the NHS England study to estimate the distances travelled, combined this with statistics on the composition of Dutch travel modes, and finally used Ecoinvent to convert the trips into effects. For all these estimates, it is important to know the system boundaries of the bottom-up data and ensure that the same characterisation factor is used to convert the emissions into impacts. Once these are aligned, it is a matter of adding the bottom-up results to the top-down results.

5.5.1.2 Other sources of health sector emissions

Within the health system there are direct emissions sources of fluorinated gases that are not accounted for in an EEIO, including gases used in anaesthesia and the propellants in MDIs. These sources have been found to contribute significantly to some national health system footprints, with NHS England finding these emissions contribute over 2% of its footprint.²⁶

International data on the use of anaesthetic gases and MDIs is sparse, with data for Annex 1 nations estimated in the United Nations Framework Convention on Climate Change (UNFCCC) accounts.²⁷ These emissions represent a significant proportion of sector emissions and are specific to the health context. National data on usage should therefore be sought during the inventory development process, and if data is unavailable a plan should be made to collect data and quantify these emissions on updating the baseline.

²⁶ Greener NHS. (2021). Putting anaesthetic-generated emissions to bed. Retrieved from Greener NHS: www.england.nhs.uk/greenernhs/whats-already-happening/putting-anaesthetic-generated-emissions-to-bed/

²⁷ UNFCCC. (2021). GHG data from UNFCCC. Retrieved from GHG data from UNFCCC: unfccc.int/process-and-meetings/transparency-and-reporting/greenhouse-gas-data/ghg-data-unfccc/ghg-data-from-unfccc

When calculating these emissions, the recommended approach is to multiply mass of the greenhouse gas used within the product, i.e. the propellant or the anaesthetic, by its global warming potential as defined by the UNFCCC.²⁸

5.5.1.3 Emissions factors

Several reputable government and international organisations provide emissions factors for a range of emissions sources. Some examples are the IPCC Emissions Factor Database (EFDB),²⁹ the UK Government Conversion Factors for Corporate Reporting,³⁰ and the EPA Emission Factors Hub.³¹ The GHGP provides a wider list for life cycle databases.³²

A single database may not provide emissions factors for all necessary sources. In which case, a combination can be used (taking care to ensure system boundaries are consistent). It is best practice to use more conservative emissions factors if the specifics of a source are not known, e.g. an unknown fuel. There may also be nation-specific data, depending on the source and nation. For some sources, such as anaesthetic gases and MDIs, there may be information that can be obtained directly from the supplier.

5.5.2 Undertaking the bottom-up calculations

The relevant emissions factor for each unit is combined with the amount of that unit to give a total emission inventory value.

For example:

$$\begin{array}{rcccl}
 \textit{electricity usage} & & \textit{electricity} & & \textit{emissions} \\
 \textit{(kWh)} & & \textit{emissions factor} & = & \textit{inventory value} \\
 & \times & \textit{(kgCO}_2\textit{e/kWh)} & & \textit{(kgCO}_2\textit{e)}
 \end{array}$$

In practice, due to the amount of data, this can be time consuming. Calculations can be done manually using a spreadsheet or similar, or there are several online tools, such as HCWH's Climate Impact Checkup tool,²⁵ that can be employed.



28 UNFCCC. (2021). Global Warming Potentials. Retrieved from UNFCCC: unfccc.int/process/transparency-and-reporting/greenhouse-gas-data/greenhouse-gas-data-unfccc/global-warming-potentials

29 IPCC. (2006). Emissions Factor Database (EFDB). Retrieved from www.ipcc-nggip.iges.or.jp/EFDB/find_ef.php?reset=

30 UK Government (2021). UK Government GHG Conversion Factors for Company Reporting. Retrieved from www.gov.uk/government/collections/government-conversion-factors-for-company-reporting

31 EPA. (2021). GHG Emission Factors Hub. Retrieved from www.epa.gov/climateleadership/ghg-emission-factors-hub

32 *Life Cycle Databases | Greenhouse Gas Protocol* (ghgprotocol.org)

5.6 REPORTING FRAMEWORKS

The main output of the calculations will be a GHG inventory. Through adoption of common reporting frameworks for the emissions baseline, greater comparison and benchmarking between health systems is enabled. [Table 8](#) sets out three reporting frameworks that are suggested to provide insight into the sector's emissions. Summary details of these reporting frameworks and signposting to other relevant sections of this Methodology are also included.

Table 8: Suggested reporting categorisations for a national health sector emissions baseline.

Framework	Details	Required for reporting?	Pros/cons
System of Health Accounts	Depending on the scope of the baseline this can include up to 35 categories as described in Table 4	Yes	<p>Pros: Provides a framework for standard reporting for expenditure on health globally</p> <p>Cons: Does not necessarily account for all emissions as it depends on scoping of baseline</p>
Emissions scopes derived from the GHGP	Based on the reporting framework described in the GHGP, this framework has been adjusted to give the definitions detailed in Appendix A Table 18	Yes	<p>Pros: Provides a framework to differentiate direct and indirect emissions and classify different emissions sources in the supply chain</p> <p>Cons: Boundaries need to be carefully considered and health specific sources may be difficult to categorise</p>
Supply-chain categorisation	The health sector supply-chain categorisation used to present results in the <i>Global Roadmap for Health Care Decarbonization</i> . This categorisation is shown in Appendix A Table 19, with further detail available in the Technical Annex of the <i>Global Roadmap for Health Care Decarbonization</i> .	No	<p>Pros: Gives a comprehensive breakdown of emissions sources that is more applicable to the health sector directly and can be linked to GHGP scopes as detailed in Table 19</p> <p>Cons: Additional work required to report against these categories beyond the core categorisations above. Different health systems may find other supply-chain breakdowns more informative/relevant to their needs</p>

Additional categorisations and insights may be produced to suit the national context (such as the UNFCCC national reporting framework³³ and submissions to NDCs). When doing this, the individual should consider the national setting in which the study has been undertaken, how the inventory for the country or health system has been established, and any resulting emissions budgets that may exist, and therefore decide how to report in a complimentary and aligned way. Such insights might be included in the relevant NDC, Government Transparency reports, or national ministry reports.

³³ IPCC. (2019). *Refinement to the 2006 IPCC Guidelines for National Greenhouse Gas Inventories*. Retrieved from Task Force on National Greenhouse Gas Inventories: www.ipcc-nggip.iges.or.jp/public/2019rf/index.html

5.7 DATA QUALITY

When designing a footprinting methodology, a quality assurance approach should be established at the outset to ensure calculation methods are appropriate and input data is of sufficient quality.

Data and methods should be checked based on criteria such as age, technology, capacity of the generating organisation/body, independent verification protocols applied, and similar. Benchmarking against wider data in the literature should be used where appropriate. This means that all incoming data and sources used should be reviewed for quality, reliability, and appropriateness for the requirements of the assessment.

Calculations should be checked following a formal quality assurance process by individuals independent of the original calculation. Calculation flows should be followed through to verify they function as expected. Spot checks and sensitivity assessments should be applied.

In some circumstances, further quality assurance and subject matter expertise may be desired from academia to subject the work to leading academic scrutiny.

5.8 OUTCOMES FROM THIS SECTION

The methodology described in this section should allow the milestones on the roadmap process described in [Table 9](#) to be achieved.

Table 9: Outcome of processes covered in this section.

Roadmap component	Description of outcomes
5.1 Study boundary conditions (scope)	A clear description about which activities and services are considered within the boundary of the national health sector and included in the baseline footprint.
5.4.1 Input data (top-down) 5.5.1 Input data (bottom-up)	An understanding of the data required to produce an initial baseline, and the types of data that can be used to further enhance and refine future footprint calculations. This includes the expenditure datasets that can be used for top-down assessments, and bottom-up data on processes and activities that can be used in a hybrid model.
5.4 Establishing a baseline using a top-down methodology	Clear process for performing top-down calculations within the baseline footprint for the health system.
5.5 Including bottom-up data to create a hybrid model	Clear process for performing bottom-up calculations within the baseline footprint for the health system.
5.6 Reporting frameworks	Understanding the options for reporting emissions, and the benefits of each for benchmarking against other nations, target setting, and progress tracking.
5.7 Data quality	Clear criteria for assessing the quality of available data and ensuring the baseline footprint is robust.



DERIVING A TRAJECTORY

Understanding how quickly healthcare systems need to decarbonise requires the projection of the sector's emissions into the future, followed by comparison between the projection and a Paris-aligned emissions trajectory. This process will likely lead to the identification of an emissions gap between a business-as-usual or "no further climate action" future for the sector and the target trajectory.

For this process to be possible, a target rate of decarbonisation must first be defined in relation to a global budget for the health system through the process shown in [Figure 12](#) and described in the following sections.

This section begins by covering the key principles to follow in the derivation of a target trajectory and introduces some suggested sources that may inform this process. Following this, detail is given on how to produce a national target trajectory. Three potential methods are identified and explained along with a discussion of the pros and cons of each.

Figure 12: Workflow for deriving a trajectory

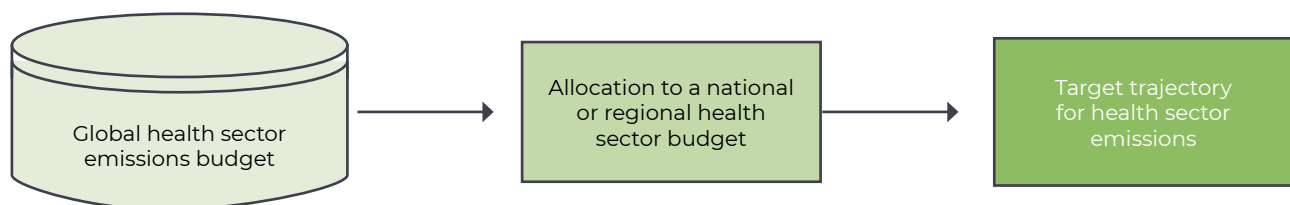

6.1 KEY CONSIDERATIONS WHEN SETTING BUDGETS AND TARGET TRAJECTORIES

Four important principles should be applied when calculating an appropriate decarbonisation trajectory:

- 1. Sufficient limiting of emissions:**
 - Target trajectories should be consistent with the emissions budgets established by the IPCC as being compliant with the efforts to achieve the 'no more than a 1.5°C global mean warming' target established in the 2015 Paris Agreement.³⁴
 - These budgets are based on several climate models, which consider scenarios through to 2100.
- 2. Common but differentiated responsibilities and respective capabilities:**
 - While all countries need to mitigate further climate change, those countries with the largest historical emissions and greatest capacity to act should act quickest and with greatest ambition.
 - They should also contribute to the provision of the means of implementation necessary for developing countries to meet their own targets, as defined in articles 4.5, 9, 10, and 11 of the Paris Agreement.
 - The contraction and convergence principle, as recognised by UNFCCC, states that all countries should achieve equal emissions per capita (convergence), then reduce their emissions (contract) by a target date to a level in line with global targets. In practice, this reinforces the conclusion that countries with highest per capita emissions should decarbonise quickest.
- 3. Global to national downscaling:**
 - Global budgets need to be allocated to countries based on a method that acknowledges common but differentiated responsibilities and respective capabilities as well as current and future demographics and level of development.
 - This step is crucial to ensuring the global sector budget is fairly distributed across nations. If this is not achieved as countries allocate their own budget, there is a risk that the sum of the budgets identified at the national level is greater than a global allocation for the sector that is compliant with the goals of the Paris accord.
- 4. Global to sector downscaling:**
 - The way current and future trends in health will change the proportion of human activity devoted to the provision of healthcare needs to be considered.

³⁴ Considering recent scientific evidence, HCWH consider the 1.5°C target to be the only acceptable target to protect global public health from the impacts of climate change, and that Paris Agreement-compliant trajectories will therefore be considered as those set with emissions budgets that allow for 1.5°C to be met.

6.2 FUTURE TRENDS THAT CAN INFORM TARGET TRAJECTORIES

The target rate of decarbonisation should factor in both the current level of emissions as identified in the baseline assessment, and the socio-economic trends observed in the national context. For developing nations, it is critical that health systems are allowed to further develop towards the goal of universal health coverage, while for some nations undergoing rapid growth or contraction in population, the demand for health services will need to reflect the changing needs of the population. These trends must be balanced with the need to decarbonise while identifying an ambitious but realistic rate of decarbonisation to target.

6.2.1 Population

Population forecasts are needed to establish an emissions trajectory in terms of emissions per capita. Population projections can be sourced from the UN's World Urbanization Prospects. National statistics offices may also be able to provide this data.

6.2.2 GDP

GDP data can provide a useful proxy to identify and scale the target trajectories for each country, as it is one of very few figures for which projections to 2100 are available. GDP projections can be sourced from the World Bank National Accounts data, and OECD National Accounts data files.³⁵

6.2.3 Healthcare expenditure

Projections of healthcare expenditure are needed to calculate the ratio of health expenditure to GDP for each year to 2100. Health expenditure projections are available to 2050 from the University of Washington Financing Global Health project.³⁶ For 2051-2100 a fixed ratio of healthcare expenditure to GDP can be used in the absence of better data.

6.3 CALCULATING HEALTHCARE NATIONAL BUDGETS

When seeking to produce a national budget, the level of ambition shown should reflect national decarbonisation strategies as well as the HCWH estimated global budget for the sector. The global health emissions budget can be attributed to different countries acknowledging common but differentiated responsibilities and respective capacity. A country's decarbonisation trajectory is defined as an emissions pathway that aligns with the global emissions healthcare sector budget.

Depending on the national characteristics of the focus country, an emissions budget will vary on an absolute and per-capita basis. For developing countries with rapidly growing populations, it will require an appropriate profile for decarbonisation whilst also ensuring healthcare provision for all citizens within the absolute budget.

³⁵ World Bank National Accounts. data.worldbank.org/indicator/NY.GDP.PCAP.CD

³⁶ University of Washington. (2019). Financing Global Health - All-cause total health spending (forecast reference health scenario). Retrieved from Viz Hub: vizhub.healthdata.org/fgh/

CLIMATE EQUITY

The selection of an appropriate trajectory is a political choice, which carries with it questions of climate equity. In countries where government policy has not already defined an emissions reduction trajectory, health ministries will need to decide when and how quickly they reduce their emissions. This choice needs to consider the country's historical emissions, its current per capita emissions, and its relative wealth. Countries with higher historical emissions, higher per capita emissions, and higher wealth will need to peak their emissions sooner and reduce them faster.

Where appropriate, countries have the option to adopt a different method than the one set out here.

6.3.1 Deriving a national target trajectory

This methodology sets out three options to produce a target trajectory for emissions from a national health system. These are presented in the following sections along with discussion around the pros and cons for each. When selecting an approach, the national regulatory framework should be considered, and the decision process should include key stakeholders to ensure the most appropriate trajectory is selected for the local context.

6.3.1.1 Track NDC commitments

This approach seeks to produce a target trajectory for the health system that scales in line with overall national emissions decarbonisation plans. Where NDCs are not aligned with 1.5°C goals by 2050, this trajectory will not be aligned with the Paris Agreement.

Table 10: Pros and cons of adopting a target trajectory aligned with a nation's NDC.

Pros of approach	Cons of approach
<ul style="list-style-type: none">● Alignment with national target setting and reporting frameworks	<ul style="list-style-type: none">● Depending on ambition of national NDCs this approach might not lead to a Paris-aligned national target trajectory● NDCs can change and undergo updates, which could lead to shifting targets and challenges around messaging and implementation.



6.3.1.2 Align with intermediate targets

Identify target years to achieve intermediate targets on the pathway to net zero, for example at 50% and 80% reduction relative to the baseline year and fit a trajectory curve around these points between the baseline year and the end point of net zero by 2050. The selection of intermediate targets should reflect either the national targets within the NDC (without following the overall target profile) or the level of ambition required to be Paris-aligned.

Table 11: Pros and cons of adopting a target trajectory based on intermediate target setting.

Pros of approach	Cons of approach
<ul style="list-style-type: none"> ● Clear and easy to communicate trajectory tied to intermediate targets that allow for progress checking 	<ul style="list-style-type: none"> ● Trajectory may misalign with national targets and other policy

6.3.1.3 Adopt national target trajectories from HCWH’s Global Roadmap

For nations covered within the *Global Roadmap for Health Care Decarbonization*, the cumulative emissions budget assigned in this modelling may be used as a starting point to produce a curve consistent with this budget to 2050.

Table 12: Pros and cons of adopting a target trajectory from HCWH’s published Global Roadmap.

Pros of approach	Cons of approach
<ul style="list-style-type: none"> ● Full trajectories available through to 2050 in alignment with a Paris global emissions budget. These trajectories were produced following a contraction and convergence-based method. 	<ul style="list-style-type: none"> ● Trajectory may misalign with national targets and other policy ● Target trajectories were not produced for all nations and regions in the study



6.3.2 Compatibility with the HCWH Global Roadmap emissions budget

When a trajectory is designed, the cumulative emissions from the sector across the trajectory period should be reported and compared against the global budget established in the *Global Roadmap for Health Care Decarbonization*, along with the proportion of the global population to which this trajectory applies and the proportion of GDP. Where this cumulative trajectory represents a greater share of the emissions budget than would be allocated based on population and GDP, justification for the greater emissions allocation should be presented.

6.3.3 Downscaling a national emissions budget to a sub-national scale

Where a national emissions budget needs to be downscaled to a regional or municipal scale, gross value added (GVA) data, population, or health expenditure data can be used to calculate the proportion of economic activity or healthcare activity that is contributed by that region or municipality. The national budget can be downscaled by multiplying by the ratio of sub-unit contribution to the national total.

6.4 OUTCOMES FROM THIS SECTION

The methodology described in this section should allow the milestones on the roadmap process described in [Table 13](#) to be achieved.

Table 13: Outcome of processes covered in this section.

Roadmap component	Description of outcomes
6.1 Key considerations when setting and target trajectories	Clear understanding of how to identify a Paris-aligned budget in line with the principles of common but differentiated responsibility and climate equity
6.2 Future trends that can inform target trajectories	Understanding how socio-economic trends will influence the future demand for health services and linking this with the defined carbon budget to identify a target decarbonisation profile aligned with the national context
6.3.1 Deriving a national target trajectory	Calculation approach selected to identify and produce a target trajectory compatible with the goals of climate-smart healthcare
6.3.2 Compatibility with the HCWH Global Road Map emissions budget	Appreciation of the steps needed to ensure the budget identified for the national health system is consistent with the wider global budget and represents an equitable share of responsibility for decarbonisation
6.3.3 Downscaling a national emissions budget to a sub-national scale	Calculation approach and principles to apply when downsampling a national budget to the regional level identified



CREATING A PROJECTION

To understand future trends in emissions relative to the target trajectory, projections for future scenarios should be sought. Such projections may be produced based on the emissions baseline, projected growth in demand for healthcare services, and projected decarbonisation rates for global industries and emission sources. This process is shown in [Figure 13](#) and described in the following pages.

A review of available datasets tailored to the national context should be the first step in this process. Where improved datasets are not found, the sources used for the *Global Roadmap for Health Care Decarbonization* may be used. It should be noted that these sources were chosen due to global applicability, and that the underlying data sources and projections may have since become superseded. As more detailed data becomes available in future, baseline models and projections may be updated as required.

Figure 13: Workflow for creating a projection.

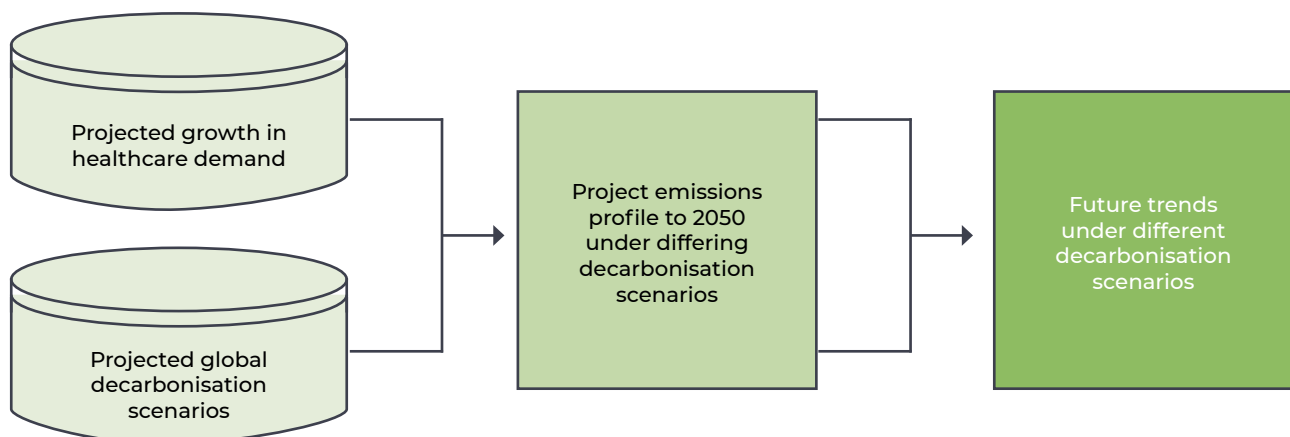

7.1 EXPENDITURE PROJECTIONS IN HEALTHCARE TO 2050

Assuming no other change to the emissions intensity of health and the economy, a projection of health sector emissions can be made by upscaling the emissions of the baseline year by the ratio of forecast expenditure in a year to the expenditure in the baseline year. National annual health expenditure projections are needed to calculate the upscaling ratio. These can be national figures or alternatively can be sourced from global projections.³⁷

7.2 WIDER ECONOMY DECARBONISATION

Current and future decarbonisation policies and technology changes will reduce the emissions intensity of the economy over time. This means healthcare will see a reduction in its emissions without acting itself. The roadmap should take this into account so that healthcare cannot claim to be making reductions for which the credit lies with other sectors.

7.2.1 Primary production sectors

Primary production sectors, for example electricity generation or steel production, determine the emissions intensity of an economy to a significant degree. National governments may have detail on the emissions futures for primary production sectors in their countries. Alternatively, the International Energy Agency's (IEA) Energy Technology Perspectives (ETP) provide projections of direct emissions from primary production sectors. Those sectors typically map closely to specific sectors in EEIO, with information provided across a range of time-periods and frequencies depending on data source. The projections for emissions intensity in the key sectors can therefore be used to alter the emissions intensities of the EEIO model year-by-year over the applied study period. The ETP dataset was used within the *Global Roadmap for Health Care Decarbonization*, and the approach taken to integrating this data into the model is described in the technical annex to the report.

7.2.2 Agriculture

The agriculture sector is a primary production sector not covered by the IEA. Where national government projection is not available, an alternative projection of emissions intensity from this sector is needed. This should be sought for the national context. If these are not available the projections provided by Popp et al.³⁸ can be used as described in the *Global Roadmap for Health Care Decarbonization* and its supplementary materials.

³⁷ University of Washington. (2019). Financing Global Health - All-cause total health spending (forecast reference health scenario). Retrieved from Viz Hub: vizhub.healthdata.org/fgb/

³⁸ Popp, A., Calvin, K., Fujimori, S., Havlík, P., Humpenöder, F., Stehfest, E., . . . Tabeau, A. (2016). Land-use futures in the shared socio-economic pathways. *Global Environmental Change*.

7.2.3 Assumptions and limitations

If projections are made based on a static EEIO model, there is an assumption that the structure of the economy remains unchanged from the base year throughout the period covered by the projection. As the length of projection increases so does the uncertainty of this formation.

Literature presents methods to integrate structural change in the global economy into future projections based on IO models.³⁹ However, this is a more complicated methodology that to HCWH's knowledge has not yet been tested in the context of the healthcare sector. Projections based on static models have been used and demonstrated in the literature,⁴⁰ and provide a useful tool for assessing scale of opportunity presented by decarbonisation options.



CASE STUDY:

DECARBONISATION TRAJECTORIES (BRAZIL)

(GLOBAL ROAD MAP FOR HEALTH CARE DECARBONIZATION)

The Global Road Map for Health Care Decarbonization sets out a detailed description of its approach to calculate the global emissions budget and the calculated budget for the global healthcare sector. Based on this budget, it also outlines its approach to estimate nations' trajectories.

Emissions trajectories, defined as a plausible emissions pathway a country must follow to remain within the global emissions healthcare sector budget, were estimated based on four trajectory types described below.

Trajectory	Description	Peak year	Trend to peak year	Rate of emission decrease
Steep decline	Nations are required to immediately begin a steep decrease in emissions per capita	--		Steep
Steady decline	Nations are required to immediately follow a steadier decline in emissions per capita than the steep decliners	--		Steady

39 Wiebe, K., Harsdorff, M., Montt, G., Simas, M., & Wood, R. (2019). Global Circular Economy Scenario in a Multiregional Input–Output Framework. *Environ. Sci. Technol.*, 6362–6373.

40 Wiebe, K. S., Bjelle, E. L., Többen, J., & Wood, R. (2018). Implementing exogenous scenarios in a global MRIO model for the estimation of future environmental footprints. *Economic Structures*, 7-25.

Trajectory	Description	Peak year	Trend to peak year	Rate of emission decrease
Early peak	Nations are allowed to increase emissions up to a peak year of 2022 before steadily declining	2022	Linear	Steady, as per steady decline
Late peak	Nations are allowed to increase emissions up to peak year of 2026 before steadily declining	2026	100%	Steady, as per steady decline

In this study, per capita GDP was identified as the key criteria to assign trajectories as it offers a proxy for each country's capacity to reduce emissions and nations' current contribution to total healthcare emissions.

Taking Brazil as an example, based on per capita GDP the country was assigned to the early peak trajectory (see figure below). This trajectory requires immediate action to change course and begin implementing decarbonisation strategies together with green universal health coverage.

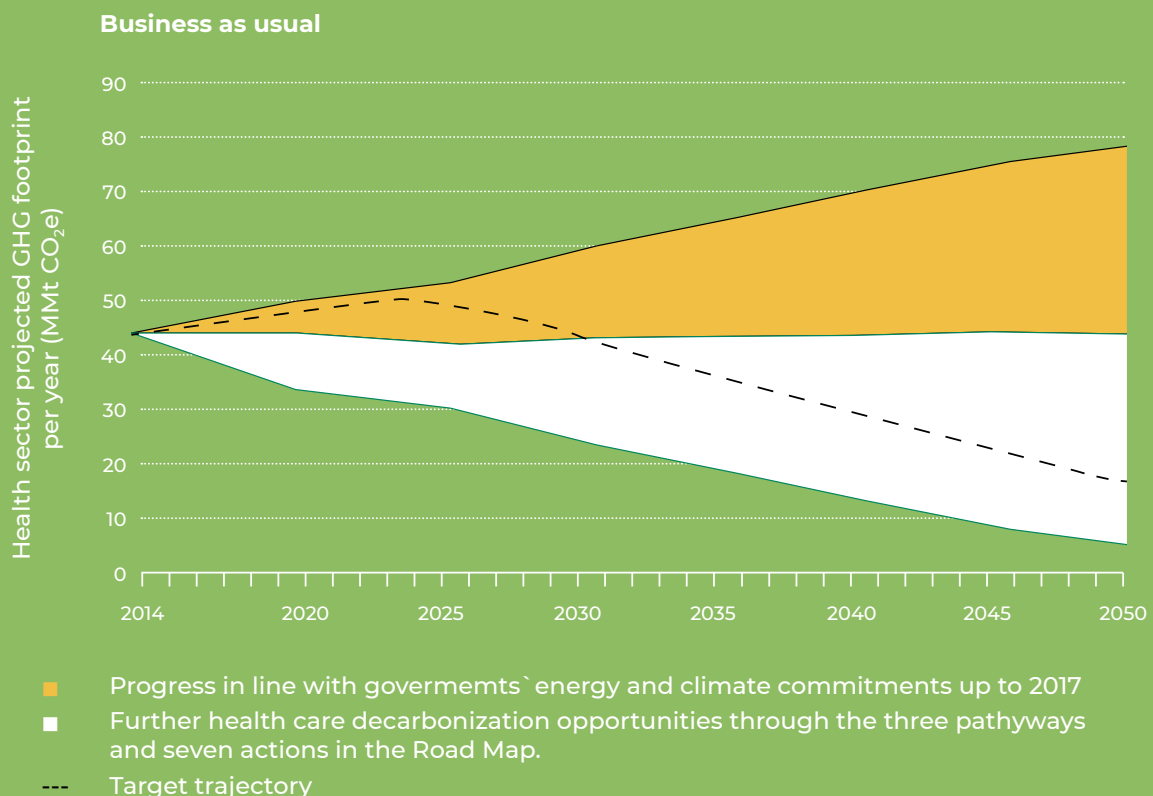

7.3 OUTCOMES FROM THIS SECTION

The methodology described in this section should allow the milestones on the roadmap process described in [Table 14](#) to be achieved.

Table 14: Outcome of processes covered in this section.

Roadmap component	Description of outcomes
Sourcing projections to use in scenario analysis	An understanding of the approach to take when seeking the best underlying datasets to explore future scenarios for health sector emissions - Starting with national level studies, and where necessary supplementing with global datasets
7.1 Expenditure projections in healthcare to 2050	A clear picture of how projections for future expenditure on health services can be used when exploring future emissions scenarios for a national health system -This enables identification and integration of such data into the wider modelling in a national roadmap
7.2 Wider economy decarbonisation	Knowledge of the steps required to gather the best available projections for economic decarbonisation to feed into wider modelling around future scenarios





MODELLING ACTIONS AND PATHWAYS

Once future scenarios have been created from the baseline, action to target high-emissions hotspots can be planned through testing the predicted scale of impact. Action on emissions can be planned and prioritised by seeking evidence for the decarbonisation potential of interventions, testing the wider impact of these interventions in the model, and then identifying priority actions based on the scale of reduction. This process is shown in [Figure 14](#) and described in the following pages.

The definition of specific action areas and pathways towards decarbonisation goals is dependent on the national context both in terms of policy backdrop and the prioritisation of action areas based on the model of healthcare delivery and associated emissions hotspots. This section discusses the principles and approach that may be used to assess at a high-level the potential decarbonisation to be achieved through defined policies and actions.

Figure 14: Workflow for modelling actions and pathways.

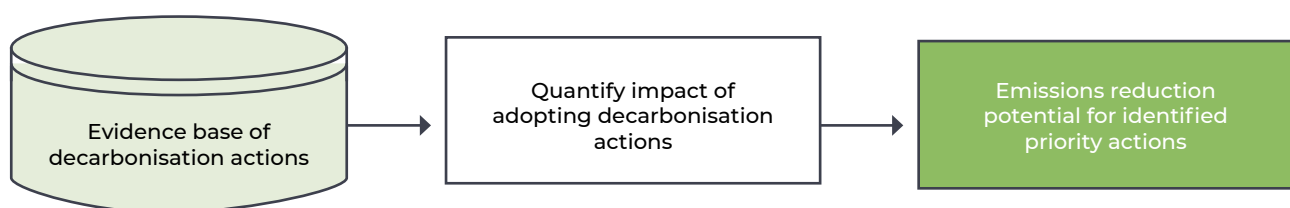

8.1 USING THE MODEL TO ASSESS DECARBONISATION ACTIONS

The model can be used to test the scale of potential for emissions mitigation strategies and to prioritise action. Through interrogating the emissions baseline and business-as-usual trajectories, emissions hotspots can be identified following the protocol outlined in section 8.2. Once interventions are identified, they can be quantified in the model using one of the mechanisms described in section 8.3. Reductions over time may be plotted, and remaining emissions targeted for additional interventions.

8.2 IDENTIFYING INTERVENTIONS

HCWH Europe's Climate-smart Healthcare programme provides guidance on actions that can be taken to reduce emissions. Further emissions reduction interventions can be identified by the following protocol:

1. Analyse the baseline to identify which sectors are contributing to the health footprint
2. Engage experts in decarbonisation in those sectors
3. Host workshops engaging healthcare professionals and managers, supply chain stakeholders, and decarbonisation experts to generate a long list of possible decarbonisation interventions
4. Evaluate the interventions for their mitigation potential, investment requirements, and implementation period
5. Short-list interventions, establish Measurement, Reporting and Verification (MRV) protocols for each and secure sign-off from leadership
6. Confirm investment requirements with funding stakeholders
7. Incorporate interventions into appropriate change plans
8. Periodically review progress and update plans
9. Identify further interventions and act, repeating the process until sufficient reductions to operate within emissions budget are achieved

Interventions can be selected to target different emissions mechanisms across the value chain, as shown in [Figure 15](#).

Figure 15: Interventions can target different emissions mechanisms across the value chain.

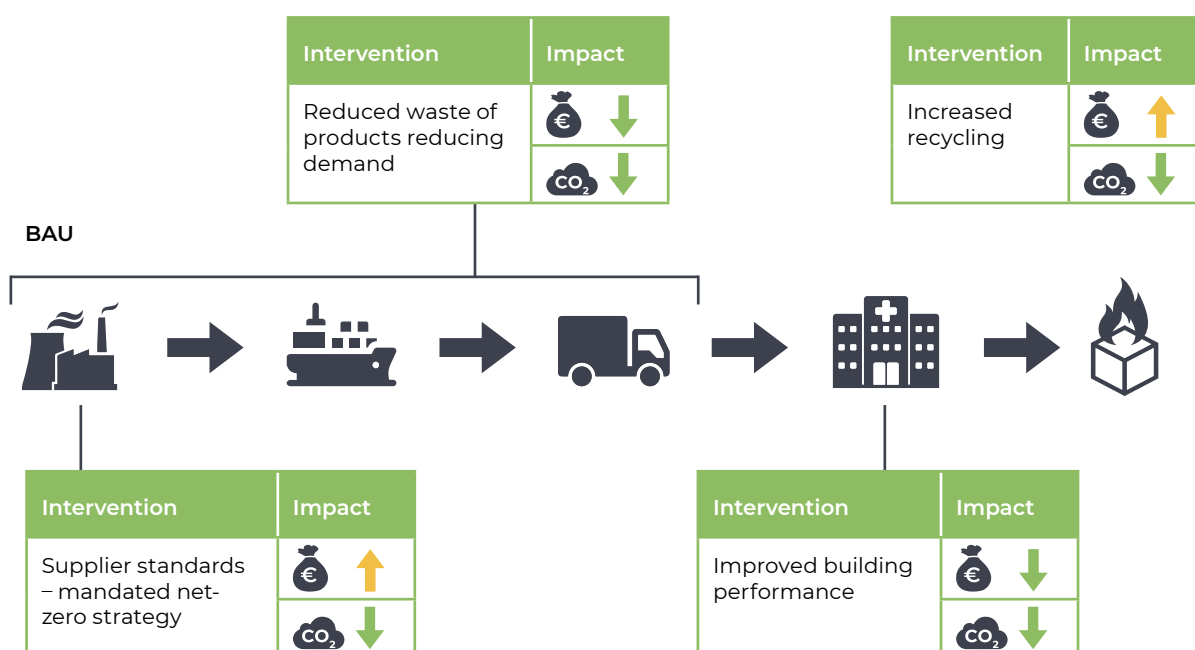

8.3 ASSESSING REDUCTION POTENTIAL OF ACTIONS

In the EEIO method, there are four ways the emissions reduction potential of interventions can be modelled, as shown in Figure 16. These allow different intervention mechanisms to be tested in the model. By adjusting the emissions intensity of a sector, or expenditure into it, potential emissions reductions can be quantified.

Figure 16: Overview of four options for implementing interventions in an EEIO-based model.

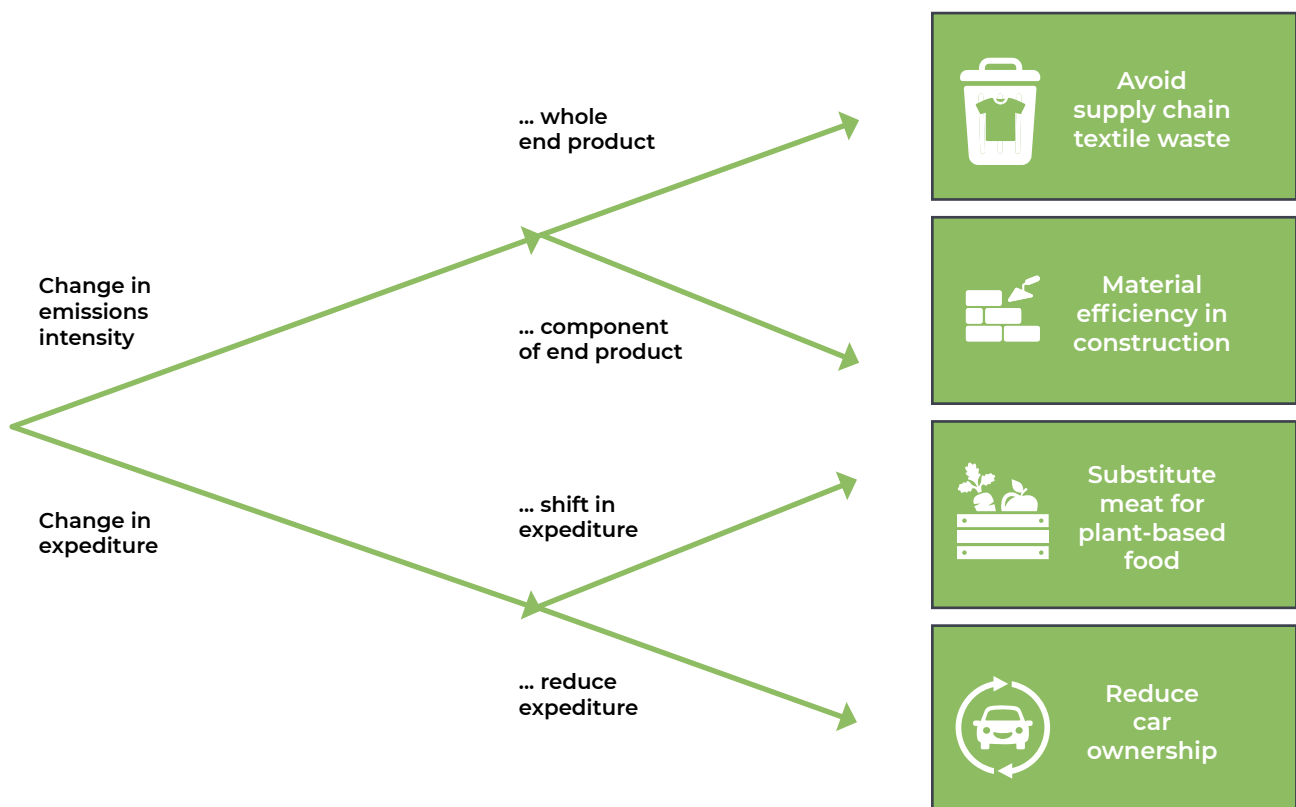

Where expenditure reductions are modelled as a result of mitigations, there is the potential for rebound effects, which can reduce estimated emissions reductions. Rebound effects occur when a reduction in expenditure in one area leads to increased expenditure in another. The increased spending will have an emissions impact, reducing any net emissions saving. A more detailed analysis can consider different scenarios for where the displaced expenditure might go and the resultant net emission estimate. These scenarios can be informed by engagement with stakeholders and subject-matter experts in each intervention area. For each modelled intervention, it should be stated clearly whether rebound effects are likely, and if so whether an attempt is made to estimate those effects. Given estimating such rebound effects over an extended period of time will require several assumptions, a clear statement of method and assumptions made should be provided.

8.4 ADOPTION RATE OF INTERVENTIONS

When applying an intervention to the model, the rate of adoption assumed between the baseline year and the end goal is key to appropriately estimating the cumulative emissions savings. Where interventions are based on defined rates of adoption from an evidence base or published targets this adoption profile may be used. Otherwise, a profile modelled on an S-curve may be assumed to align with the principle that adoption of new social behaviours or technologies typically follow an S-curve rather than a linear curve or other function.⁴¹

8.5 CALCULATING EMISSIONS GAP

If the sum of the mitigation potential of the short-listed interventions is smaller than the gap between projected future emissions and the projected emissions budget trajectory, there will be an emissions gap. This gap is calculated year-by-year over the projected period by subtracting the emissions budget from the projected emissions, after the impact of interventions have been accounted for.

The emissions gap represents the work still to be done to align the projected footprint of the health system with a Paris-aligned emissions trajectory. Subsequent revisions of the roadmap can increase the ambition or accelerate the adoption of already-modelled interventions, or identify and model further interventions, to give the full picture of the efforts required to achieve sufficient decarbonisation for a climate-smart healthcare system.

8.6 POST-PROCESSING TO CREATE DIFFERENT PERSPECTIVES

When reporting model results, several framings may be employed to provide detailed insights into aspects of the emissions inventory, and aid comparison with results from other countries. Recommended reporting frameworks are discussed below, though additional categorisations may also be chosen in line with the national context.

8.6.1 Deriving emissions reduction wedges

When tracking the potential of decarbonisation actions, it is useful to think in terms of avoided emissions. This framing lends itself to the use of decarbonisation wedges to plot and track avoided emissions. Such wedges are commonly used in the production of decarbonisation roadmaps, with an example taken from the *Global Roadmap for Health Care Decarbonization* shown in [Figure 17](#). Wedges are constructed by showing the area between the emissions trajectory where an emissions mitigation action is not implemented, with the resulting trajectory once the action has been modelled.

⁴¹ Carrillo, M., & González, J. M. (2002). A new approach to modelling sigmoidal curves. *Technological Forecasting and Social Change*, 233–241.

Figure 17: Chart illustrating use of wedges to illustrate potential emissions reduction relative to a target trajectory, source: (Health Care Without Harm & Arup, 2021)

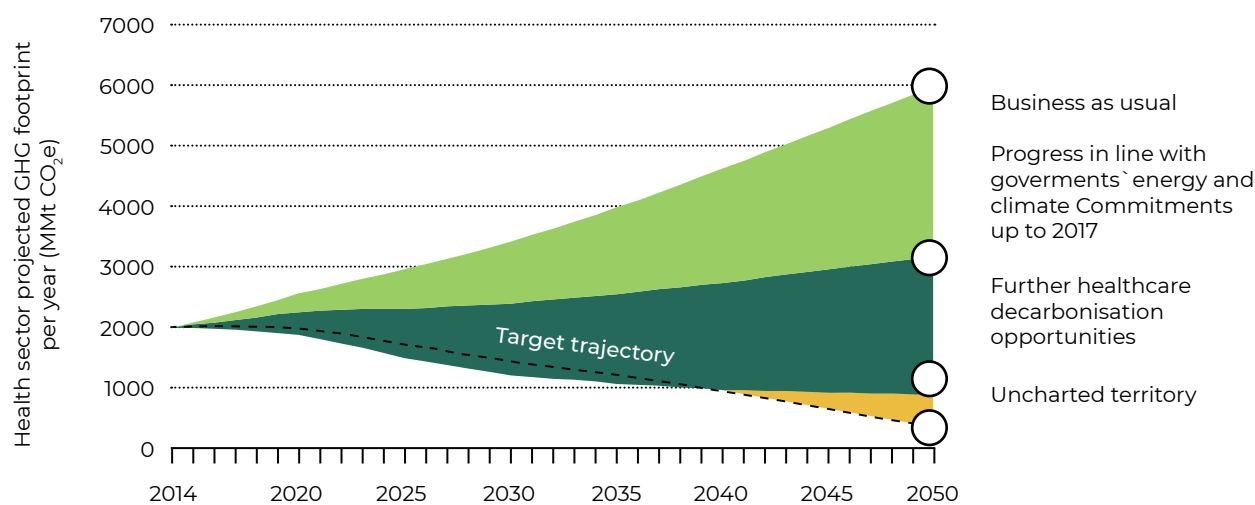

8.6.2 Pathways

Emissions trajectories can be framed in terms of health systems' institutional arrangements. At its simplest, this can be aligned to emissions directly controlled by health organisations, those that come from their supply chain, and those that require action in the wider economy and society. The advantage of this perspective is it clearly shows the emissions and interventions health organisations have direct control over, those they will need to partner with others to address, and those which they can address through advocacy and leadership.

This tripartite approach was adopted in the *Global Roadmap for Health Care Decarbonization*⁴² under the titles:

1. Pathway One: Decarbonize healthcare delivery, facilities, and operations
2. Pathway Two: Decarbonize healthcare's supply chain
3. Pathway Three: Accelerate decarbonization in the wider economy and society

8.6.3 Actions

The same emission reductions can also be organised in terms of the areas of activity from which the emissions arise, for example electricity use or transport. The *Global Roadmap for Health Care Decarbonization* identifies seven activity areas and aligns the emissions footprint and the reduction interventions with them. The advantage of this perspective is that it allows health organisations to understand how emissions arise in all areas associated with health provision, from food to waste to pharmaceutical production and use. These actions are as follows:

1. Power healthcare with 100% clean, renewable electricity
2. Invest in zero emissions buildings and infrastructure
3. Transition to zero emissions, sustainable, travel and transport
4. Provide healthy, sustainably grown, food and support climate-resilient agriculture

⁴² Health Care Without Harm & Arup. (2021). *Global Roadmap for Health Care Decarbonization*. Retrieved from [Global Roadmap for Health Care Decarbonization: *healthcareclimateaction.org/roadmap*](https://www.healthcareclimateaction.org/roadmap)

5. Incentivise and produce low-carbon pharmaceuticals
6. Implement circular healthcare and sustainable healthcare waste management
7. Establish greater health system effectiveness

These action areas were the result of a global assessment to identify the key areas in which the sector can realise emissions reductions. In a national context, these seven areas may vary in terms of significance and there may be additional action areas where focus can realise emissions reduction.

8.7 OUTCOMES FROM THIS SECTION

The methodology described in this section should allow the milestones on the roadmap process described in [Table 15](#) to be achieved.

Table 15: Outcome of processes covered in this section.

Roadmap component	Description of outcomes
8.2 Identifying interventions	Understanding how to frame and test nation-specific decarbonisation policies. The interventions used will depend on the national context, current emissions hotspots, socio-economic factors, and the structure of national health system.
8.3 Assessing reduction potential of actions	The method in this section describes how through gathering evidence on the scale of potential emissions savings associated with an identified intervention, the impact of a decarbonisation intervention if applied across the national health system may be estimated.
8.5 Calculating emissions gap	Understanding of how the remaining emissions after decarbonisation interventions have been explored and implemented in the model differ to the target trajectory.
8.6 Post-processing to create different perspectives	Understanding of the techniques and framing options that can help to communicate findings to stakeholders and policy makers. Including the potential scale of opportunity presented by decarbonisation actions, and the remaining areas requiring decarbonisation action after the interventions already explored have been implemented.



MEASURING, REPORTING, AND VERIFICATION

Effective measuring, reporting, and verification of a decarbonisation Roadmap will be critical for ensuring its ongoing success. This section outlines these procedures in more detail and highlights key considerations.

9.1 MEASURING

To understand whether the ambitions set out within a decarbonisation roadmap are being met, it is important to measure ongoing progress.

9.2 REPORTING

Reporting can come in many forms (internal or public, voluntary, or statutory) and to some extent will be dictated by the governance structure in place. It is a useful mechanism to track ongoing progress and regular public reporting is highly recommended because it provides a layer of transparency and offers an opportunity for broader public scrutiny and challenge.

The architecture for publishing a roadmap should always have the following key components:

1. The proposed pathway;
2. A summary for policy makers;
3. Stakeholder action plans; and
4. A technical report.

For reporting publicly, [Table 16](#) provides a guide in determining such a structure and can be tailored to suit the specific national or regional context. It is important to note that as health systems vary significantly between countries, variances exist in how to structure a healthcare decarbonisation roadmap.

Table 16: Suggested structures and templates for a national healthcare decarbonisation roadmap

Section 1: Context and drivers

A This section of the roadmap outlines the context of the national or regional healthcare system, and provides detail on how it is structured, governed, and financed. This section outlines the key drivers for decarbonising the healthcare sector, ranging from the ethical duty to reduce emissions, to any regional, national, or international legislation, targets, and agreements relevant to the sector.

Section 2: Baseline emissions

This section provides an overview of baseline emissions for the relevant healthcare system, broken down into its broad components, e.g. energy, transport, supply-chain.

Section 3: Identifying hotspots and priority reduction categories

This section provides a deeper analysis of the carbon footprint, taking a more granular view to identify key carbon hotspots and set priority areas for action. It is important to describe this in a way that can be understood by a wide range of both technical and non-technical stakeholders.

Section 4: Modelling pathways and setting a trajectory

This section describes the modelled pathways and sets the final trajectory towards net zero. Here, the actions planned to achieve net zero should be set out and how these actions will impact emissions on the chosen trajectory. For example, business as usual emissions may be charted against the chosen trajectory to demonstrate the proportional role these different interventions will play towards achieving the overall goal.

Section 5: Implementation

This section outlines how the decarbonisation roadmap will be implemented, detailing the chosen governance structure, and defining roles and responsibilities in delivering the plan. In this section, actions planned to address policy gaps and to support stakeholders to meet the aims of the roadmap should be outlined.

Section 6: Measuring, reporting and verification

This section details the plans and procedures for measuring, reporting, and verifying the decarbonisation roadmap. Purpose, responsible parties, and timeframes should be defined.

As more information becomes available and additional opportunities for emissions mitigation present themselves, future editions of the roadmap can be used to close any residual emissions gaps. An iterative approach to the identification of further opportunities and modelling reduction potential is key to aligning with the target trajectories and maximising the emissions mitigation that can be achieved.

Frequency is a key consideration when establishing reporting processes. Some key factors to consider include:

- **Governance structures:** Different stakeholders within the governance structure will have their own reporting requirements. To promote efficiency, effort should be made to streamline these requirements.
- **Data sources, availability, and improvement:** A decarbonisation roadmap will rely on data coming from a variety of sources. These sources, along with data availability will impact the frequency of reporting. Any significant changes or improvements to these parameters may also impact the chosen frequency.
- **Resourcing:** Reporting processes can often be time consuming and resource intensive. It is important, therefore, to establish efficient processes and procedures to support.
- **IO updates:** IO models are unlikely to be updated on a regular basis. If a decarbonisation roadmap is heavily dependent on IO data and modelling, this is likely to create significant challenges in reporting on progress, due to data availability, and dictate reporting frequency.

9.3 VERIFICATION

Verification of a healthcare carbon footprint, decarbonisation roadmap, and any public reporting can provide an additional layer of internal and public confidence and assurance. A good verification process should include a comprehensive audit of calculations, processes, and structures. ISO 14046 Part 3 (Specification with guidance for the validation and verification of greenhouse gas assertions)⁴³ includes the following detail as a minimum for its validation and verification scope:

1. Organisational boundaries or the GHG project and its baseline scenarios;
2. Physical infrastructure, activities, technologies, and processes of the organisation or GHG project;
3. GHG sources, sinks and/or reservoirs;
4. Types of GHGs; and
5. Time period.

In general, there are three options for verification:

- **Internal:** This would be conducted by someone within the organisation, but from a team or department that is different from those responsible for developing the carbon footprint and decarbonisation roadmap. The person responsible for conducting the verification will require skills in environmental analysis and audit.
- **Peer:** This option is similar to the option above, but in this instance the audit will be conducted by a different organisation. Again, those responsible for delivering this audit should sit separate from the carbon footprinting and road mapping process. By moving the verification to another organisation, this option provides enhanced confidence in the audit process.

43 ISO - ISO 14064-3:2019 - Greenhouse gases — Part 3: Specification with guidance for the verification and validation of greenhouse gas statements

- External: An independent external consultant would conduct this. As the consultant will lie outside the footprinting and roadmapping process, this option provides the highest level of confidence, particularly to the public.

According to ISO 14064 Part 3,⁴³ the key assessments that a validator or verifier should make are around the sources and magnitude of potential errors, omissions, and misrepresentations. An assessment should be made around the inherent risk of a material discrepancy, the risk that the controls of the organisation will not prevent or detect a material discrepancy, or the risk that the validator will not detect a material discrepancy that has not been corrected by organisational controls.

9.4 CONTINUOUS IMPROVEMENT

As the decarbonisation roadmap is implemented, the practitioner is likely to experience multiple changes, such as political and structural changes, as well as improvements in data quality and granularity. A healthcare carbon footprint and decarbonisation roadmap should therefore be subject to periodic review and update via a continuous improvement process. This will ensure the roadmap remains relevant, ambitious and achievable. PAS 2080⁴⁴ gives some recommendations for continual improvement that are applicable here. These are:

- Establish and manage a process of continual improvement;
- Adapt the GHG quantification methodology based upon data availability, to ensure quantification is as accurate as possible and to minimise uncertainty;
- Maintain an inventory of most relevant, up to date data; and
- Periodically review targets to ensure they are still aligned with trajectories and desired outcomes.

9.5 OUTCOMES FROM THIS SECTION

The steps described in this section should allow the milestones on the roadmap process described in [Table 17](#) to be achieved.

Table 17: Outcome of processes covered in this section.

Roadmap component	Description of outcomes
Measuring, reporting, and verification framework	Measuring and reporting framework developed, incorporating approaches to verification and continuous improvement
Roadmap structure	Clearly planned and defined structure for the decarbonisation roadmap

⁴⁴ PAS 2080 Carbon Management in Infrastructure verification | BSI ([bsigroup.com](https://www.bsigroup.com))

REFERENCES

- Carrillo, M., & González, J. M. (2002). A new approach to modelling sigmoidal curves. *Technological Forecasting and Social Change*, 233–241.
- EPA. (2021). GHG Emission Factors Hub. Retrieved from www.epa.gov/climateleadership/ghg-emission-factors-hub
- Greener NHS. (2021). Putting anaesthetic-generated emissions to bed. Retrieved from Greener NHS: www.england.nhs.uk/greenernhs/whats-already-happening/putting-anaesthetic-generated-emissions-to-bed/
- Health Care Without Harm & Arup. (2021). Global Roadmap for Health Care Decarbonization. Retrieved from Global Roadmap for Health Care Decarbonization: healthcareclimateaction.org/roadmap
- IPCC. (2006). Emissions Factor Database (EFDB). Retrieved from www.ipcc-nggip.iges.or.jp/EFDB/find_ef.php?reset=
- IPCC. (2018). Global Warming of 1.5°C. An IPCC Special Report on the impacts of global warming of 1.5°C above pre-industrial levels related global greenhouse gas emission pathways, in the context of strengthening the global response to the threat of climate change, sus. Retrieved from www.ipcc.ch/sr15/
- IPCC. (2019). Refinement to the 2006 IPCC Guidelines for National Greenhouse Gas Inventories. Retrieved from Task Force on National Greenhouse Gas Inventories: www.ipcc-nggip.iges.or.jp/public/2019rf/index.html
- ISIC. (2021). UN Statistics Division. Retrieved from ISIC Correspondences: unstats.un.org/unsd/classifications/Econ/ISIC.cshtml
- ISO. (2006). ISO 14040:2006 - Environmental management — Life cycle assessment — Principles and framework. Retrieved from International Organization for Standardization: www.iso.org/standard/37456.html
- Kitzes, J. (2013). An Introduction to Environmentally-Extended Input-Output Analysis. *Resources* (2), 489-503.
- Leontief, W. (1936). Quantitative input-output relations in the economic system of the United States. *Rev. Econ. Stat.*, 105-125.
- OECD. (2011). A System of Health Accounts. Retrieved from www.who.int/health-accounts/methodology/sha2011.pdf
- OECD. (2019). Health spending. Retrieved from OECD Data: data.oecd.org/healthres/health-spending.htm

Popp, A., Calvin, K., Fujimori, S., Havlík, P., Humpenöder, F., Stehfest, E., Tabeau, A. (2016). Land-use futures in the shared socio-economic pathways. *Global Environmental Change*.

UK Government, D. a. (2021). UK Government GHG Conversion Factors for Company Reporting. Retrieved from www.gov.uk/government/collections/government-conversion-factors-for-company-reporting

UNFCCC. (2021). GHG data from UNFCCC. Retrieved from GHG data from UNFCCC: unfccc.int/process-and-meetings/transparency-and-reporting/greenhouse-gas-data/ghg-data-unfccc/ghg-data-from-unfccc

United Nations. (2008). International Standard Industrial Classification of All Economic Activities Revision 4. Retrieved from UN Statistics Division: unstats.un.org/unsd/publication/seriesm/seriesm_4rev4e.pdf

University of Washington. (2019). Financing Global Health - All-cause total health spending (forecast reference health scenario). Retrieved from Viz Hub: vizhub.healthdata.org/fgh/

WBCSD, W. (2004). A Corporate Accounting and Reporting Standard Revised Edition. Retrieved from The Greenhouse Gas Protocol: ghgprotocol.org/sites/default/files/standards/ghg-protocol-revised.pdf

Wiebe, K. S., Bjelle, E. L., Többen, J., & Wood, R. (2018). Implementing exogenous scenarios in a global MRIO model for the estimation of future environmental footprints. *Economic Structures*, 7-25.

Wiebe, K., Harsdorff, M., Montt, G., Simas, M., & Wood, R. (2019). Global Circular Economy Scenario in a Multiregional Input-Output Framework. *Environ. Sci. Technol.*, 6362-6373.

World Health Organization. (2021). Global Health Expenditure Database. Retrieved from World Health Organization: apps.who.int/nha/database/ViewData/Indicators/en



APPENDIX A

EMISSIONS

CATEGORIES

Table 18: Categorisation based on the GHGP framing.

Emission type	GHGP categorisation
Scope 1	Direct emissions from on-site burning of fuels in health care facilities and the burning of fuels in the operation of healthcare owned and leased vehicles.
Scope 2	Indirect emissions from the generation of electricity, heat, and steam purchased by the health sector.
Scope 3 sub-categories	Purchased goods and services
	Capital goods
	Fuel- and energy-related activities not included in scope 1 or scope 2
	Waste generated in operations
	Business travel
	Employee commuting
	Upstream leased assets
	Downstream transportation and distribution
	Processing of sold products
	Use of sold products
	End-of-life treatment of sold products
	Downstream leased assets
	Franchises
Investments	

Table 19: Emissions categories used for reporting in the Global Roadmap for Health Care Decarbonization.

Emission type	Emissions categories	Definition of category coverage
Scope 1	Operation of buildings	Direct emissions from the operation of buildings, predominantly from boilers and incinerators.
Scope 1	Transport	Direct emissions from health sector-owned vehicle fleets as well as healthcare professionals travelling for work (excluding regular commuting)
Scope 2	Purchased electricity, heat and steam	Emissions from the generation of purchased electricity, heat, and steam purchased by the health sector, largely from the combustion of fossil fuels.
Scope 3	Business services	Emissions associated with professional services procured by the health sector, such as legal, accountancy and consultancy services.
Scope 3	Construction	Emissions associated with the construction of buildings and infrastructure, including the supply and manufacture of construction materials
Scope 3	Electricity	Emissions associated with the transmission and distribution of electricity purchased by the health sector, as well as the electricity generation sector's own supply chain.
Scope 3	Food, catering, and accommodation	Emissions associated with the food products and catering services provided by the health system and accommodation required by health workers.
Scope 3	Fossil fuels (coal and oil)	Emissions associated with the production of fossil fuel products procured by the health sector for uses including boilers, generators, and vehicles. These emissions are those generated in the production of these fuels, and does not include emissions from burning these fuels, which are included in scope 1.
Scope 3	Information and communication technologies	Emissions associated with information technology and communication services procured by the health sector, including computer systems, telecoms, and publishing activities.

Emission type	Emissions categories	Definition of category coverage
Scope 3	Manufactured fuels, chemicals, and gases	Emissions associated with the production of purchased chemicals such as soap and detergents, and gases used in the health setting.
Scope 3	Medical instruments/equipment	Emissions associated with purchased medical instruments and equipment, including computers, electronics, and optical products.
Scope 3	Other manufactured products	Emissions associated with purchased products including plastics, textiles, machinery, vehicles, and electrical equipment.
Scope 3	Other procurement	Emissions associated with goods purchased in bulk through wholesalers and intermediaries.
Scope 3	Paper products	Emissions associated with the production of paper and cardboard products procured by the health sector
Scope 3	Pharmaceuticals	Emissions associated with the production of pharmaceuticals procured by the health sector, encompassing the emissions associated with the energy, materials, and transportation of pharmaceuticals.
Scope 3	Transport	Emissions from transport services purchased by the health sector, covering freight and passenger transport.
Scope 3	Waste, water, and sanitation	Emissions associated with water collection, treatment, supply, and sewerage, and with waste disposal and recycling.

APPENDIX B

OUTCOMES FROM EACH SECTION

Table 20: Outcomes from each section.

Roadmap component	Description of outcomes
Section 3: Establishing governance structures for decarbonisation	
3.1 Understand the structure of the healthcare sector 3.2 Identify key stakeholders 3.3 Map existing policies and their supporting structures 3.4 Map existing structures and networks	A clear understanding of the structure of the healthcare system, identifying stakeholders, and mapping existing policies and relevant structures.
3.5 Develop a governance structure	Strengths and weaknesses of existing structures assessed, gaps identified, and new measures identified and implemented.
3.6 Include a process of continuous improvement	Continuous improvement process developed and implemented.
Section 4: Identifying and managing stakeholders	
4 Identifying and managing stakeholders	Stakeholders defined, identified and mapped against stages of project development, and prioritise using appropriate techniques. Stakeholder strategy developed, and stakeholders managed and monitored.

Roadmap component	Description of outcomes
Section 5: Setting a baseline	
5.1 Study boundary conditions (scope)	A clear description about what activities and services are considered within the boundary of the national health sector and included in the baseline footprint.
5.4.1 Input data (top-down) 5.5.1 Input data (bottom-up)	An understanding of the data required to produce an initial baseline, and the types of data that can be used to further enhance and refine future footprint calculations. This includes the expenditure datasets that can be used for top-down assessments, and bottom-up data on processes and activities that can be used in a hybrid model.
5.4 Establishing a baseline using a top-down methodology	Clear process for performing top-down calculations within the baseline footprint for the health system.
5.5 Including bottom-up data to create a hybrid model	Clear process for performing bottom-up calculations within the baseline footprint for the health system.
5.6 Reporting frameworks	Understanding the options for reporting emissions, and the benefits of each for benchmarking against other nations, target setting and progress tracking.
5.7 Data quality	Clear criteria for assessing the quality of available data and ensuring the baseline footprint is robust.
Section 6: Deriving a trajectory	
6.1 Key considerations when setting budgets and target trajectories	Clear understanding of how to identify a Paris-aligned budget in line with the principles of common but differentiated responsibility and climate equity
6.2 Future trends that can inform target trajectories	Understanding how socio-economic trends will influence the future demand for health services and linking this with the defined carbon budget to identify a target decarbonisation profile aligned with the national context.
6.3.1 Deriving a national target trajectory	Calculation approach to identify and produce a target trajectory compatible with the goals of climate-smart healthcare.
6.3.2 Compatibility with the HCWH Global Roadmap emissions budget	Appreciation of the steps needed to ensure the budget identified for the national health system is consistent with the wider global budget and represents an equitable share of responsibility for decarbonisation.
6.3.3 Downscaling a national emissions budget to a sub-national scale	Calculation approach and principles to apply when downscaling a national budget to the regional level.

Roadmap component	Description of outcomes
Section 7: Creating a projection	
Sourcing projections to use in scenario analysis	An understanding of the approach to take when seeking the best underlying datasets to explore future scenarios for health sector emissions. Starting with national level studies, and where necessary supplementing with global datasets.
7.1 Expenditure projections in healthcare to 2050	A clear picture of how projections for future expenditure on health services can be used when exploring future emissions scenarios for a national health system. This enables identification and integration of such data into the wider modelling in a national roadmap.
7.2 Wider economy decarbonisation	Knowledge of the steps required to gather the best available projections for economic decarbonisation to feed into wider modelling around future scenarios.
Section 8: Modelling actions and pathways	
8.2 Identifying interventions	Understanding how to frame and test nation-specific decarbonisation policies. The interventions to test will be dependent on the national context; current emissions hotspots, socio-economic factors, and structure of national health system.
8.3 Assessing reduction potential of actions	The method in this section describes how through gathering evidence on the scale of potential emissions savings associated with an identified intervention, the impact of a decarbonisation intervention if applied across the national health system may be estimated.
8.5 Calculating emissions gap	Understanding of how the remaining emissions after decarbonisation interventions have been explored and implemented in the model differ to the target trajectory.
8.6 Post-processing to create different perspectives	Understanding of the techniques and framing options that can help to communicate findings to stakeholders and policy makers. Including the potential scale of opportunity presented by decarbonisation actions, and the remaining areas requiring decarbonisation action after the interventions already explored have been implemented.
Section 9: Measuring, reporting, and verification	
Measuring, reporting, and verification framework	Measuring and reporting framework developed, incorporating approaches to verification and continuous improvement.
Roadmap structure	Clearly planned and defined structure for the decarbonisation roadmap.



HCWH Europe
Rue de la Pépinière 1,
1000 Brussels, Belgium
europe@hcwh.org
+32 2503 4911



HCWHEurope



HCWHEurope



Health Care Without Harm Europe

NOHARM-EUROPE.ORG

AUTHORS:

Zoe Parker, Climate Change Consultant – Arup
Ben Ashby, Senior Consultant – Climate Change and Circular Economy - Arup
Anna Tuddenham, Senior Climate Change Consultant - Arup
Scott Brady, Climate Programme Manager - HCWH Europe

DESIGN:

prinzdesign Berlin - Marc Prinz & Maren Maiwald

PUBLISHED:

July 2022

PHOTO CREDITS:

kamisoka | istock, Imran Khan's Photography | shutterstock, DC_Studio | envatoelements (Cover), jordano | adobestock (p.5), laflor | istock (p.9), Scott Graham | unsplash, Adam Eszes | istock (p.11), shironosov | istock (p.17), wocintechchat.com | unsplash(p.21), twenty20photos | envatoelements (p.28), SJ Objio | unsplash, SDI Productions | istock (p.34), Erdark | istock (p.35), zhaojiankang | istock (p.39), Sopone Nawoot | istock, Jirapong Manustrong | istock (p.41), Mat Napo | unsplash (p.44), Jason Blackeye | unsplash (p.44), Radboud University Medical Center (Radboudumc)(p.48), IndustryAndTravel | envatoelements (p.50), NDInfinity | istock, romankosolapov | envatoelements (p.54), instamatics | istock (p.66)

ACKNOWLEDGEMENTS:

HCWH Europe gratefully acknowledges the financial support of the European Commission (EC)'s LIFE programme, the IKEA Foundation, and Skoll Foundation. HCWH Europe is solely responsible for the content of this publication and related materials. The views expressed do not reflect the official views of the EC, IKEA or Skoll.



IKEA Foundation

